

واحد

أكتب العدد واحد بالأقلام الملونة



أبحث عن الدوائر التي بها العدد واحد ولونها



أرسم دائرة واحدة ولونها



لون المربع المحتوي على نقطة واحدة

لون المربع الذي به نملة واحد

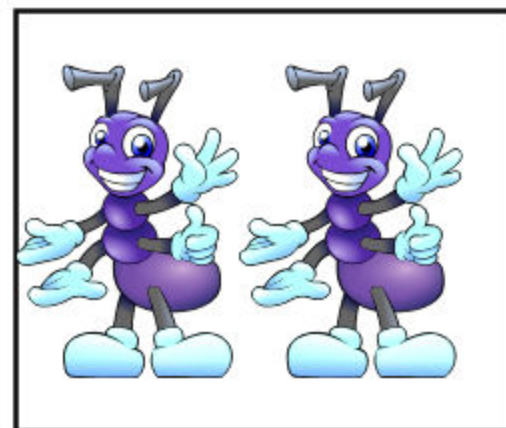
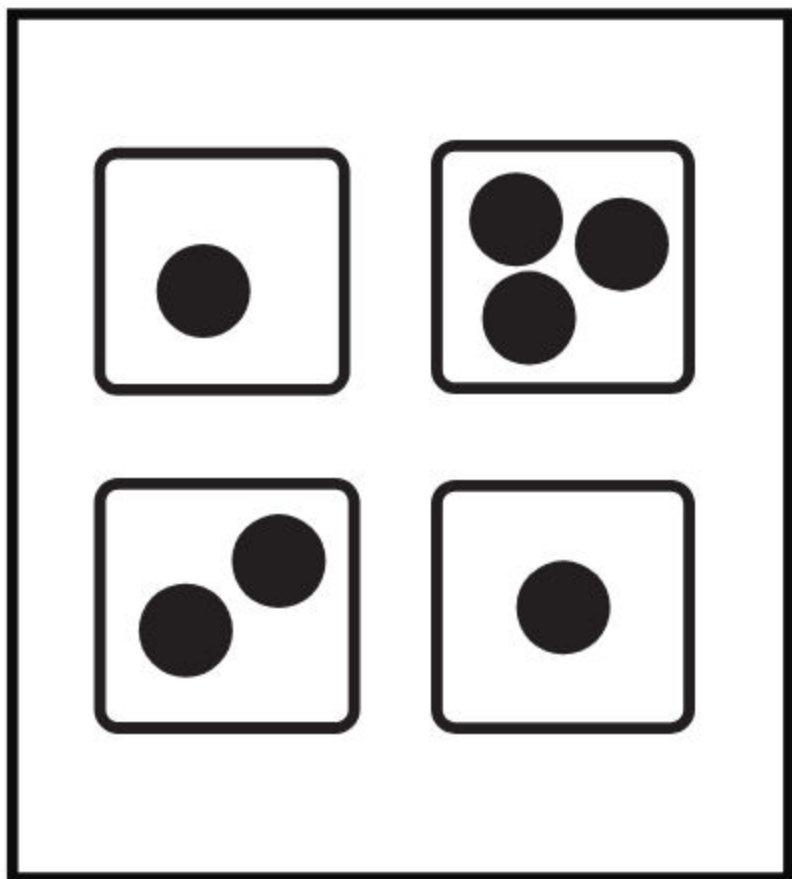

لون وعد كم زرافة في الصورة وأكتب العدد أسفل الصورة

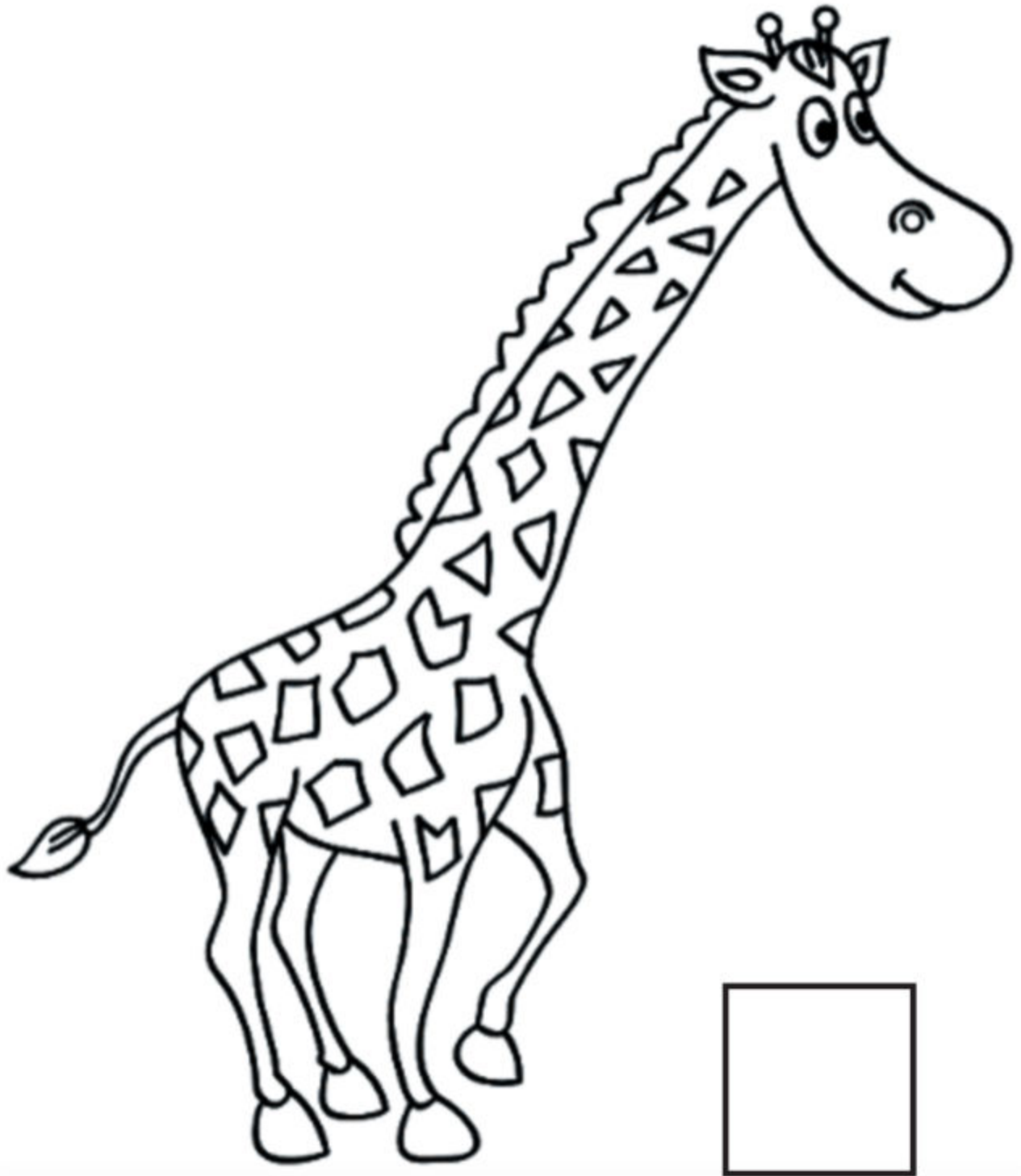



ع
اَيْنَان

أكتب العدد اثنان بالأقلام الملونة



لون الدوائر التي تحتوي على العدد اثنان

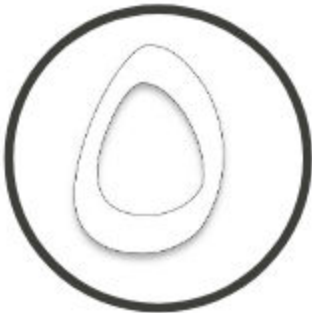

أرسم دائرتين ولونهما



لون المربع المحتوي على نقطتين

لون المربع الذي به عصفورين

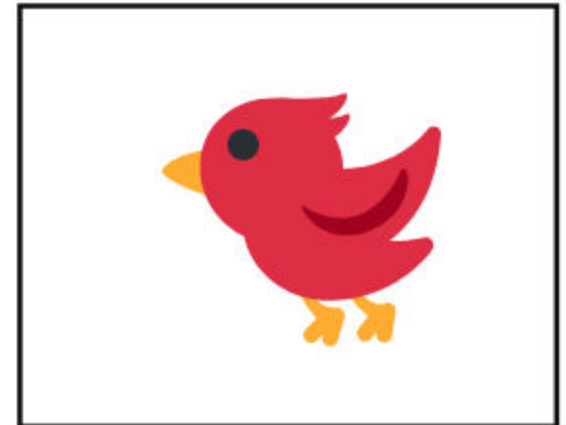
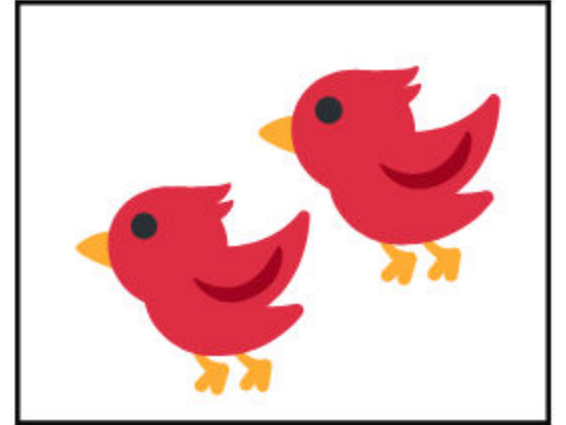
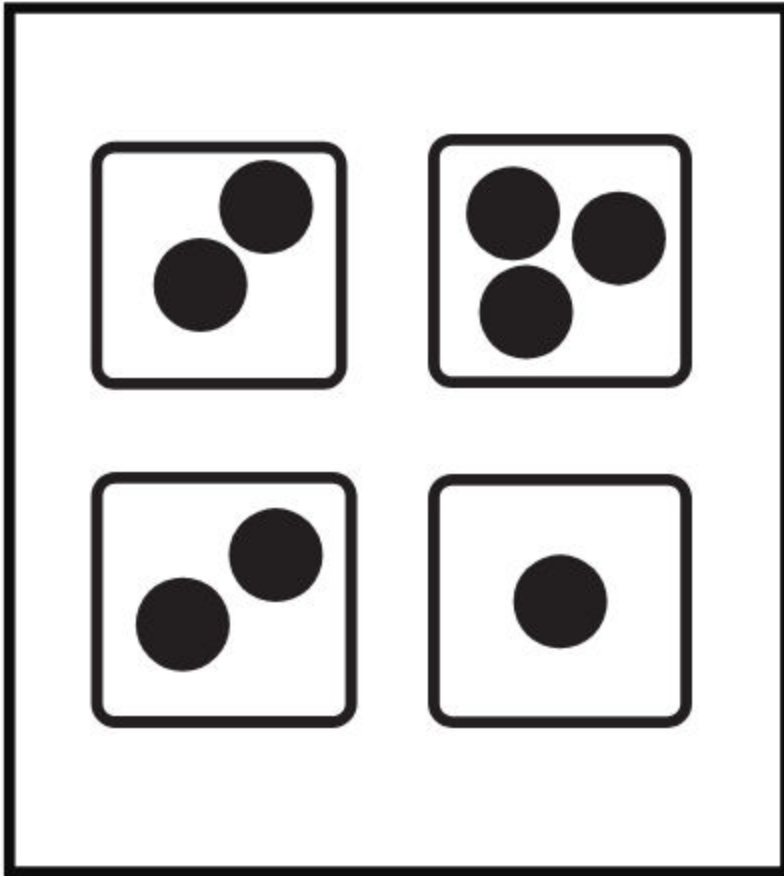

لون وعد وأكتب العدد أسفل الصورة

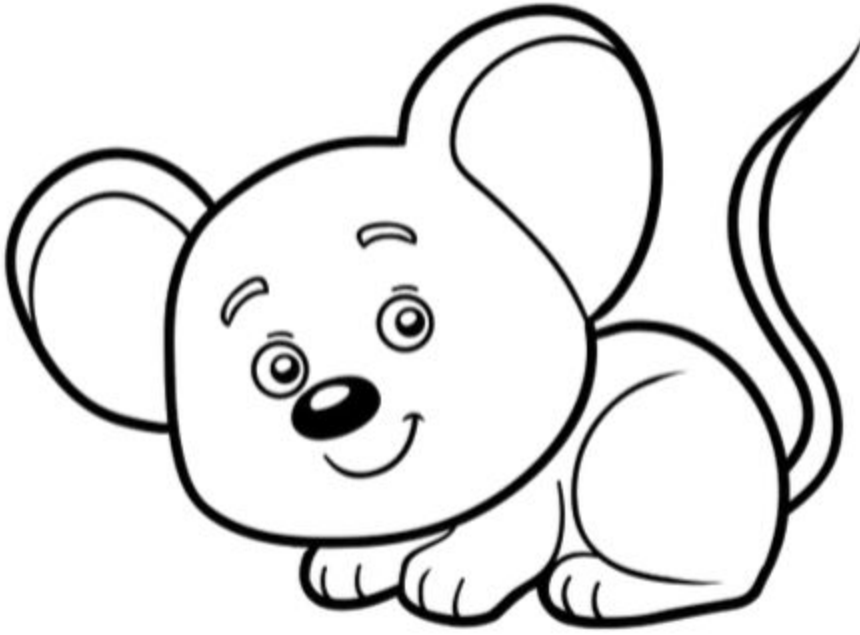
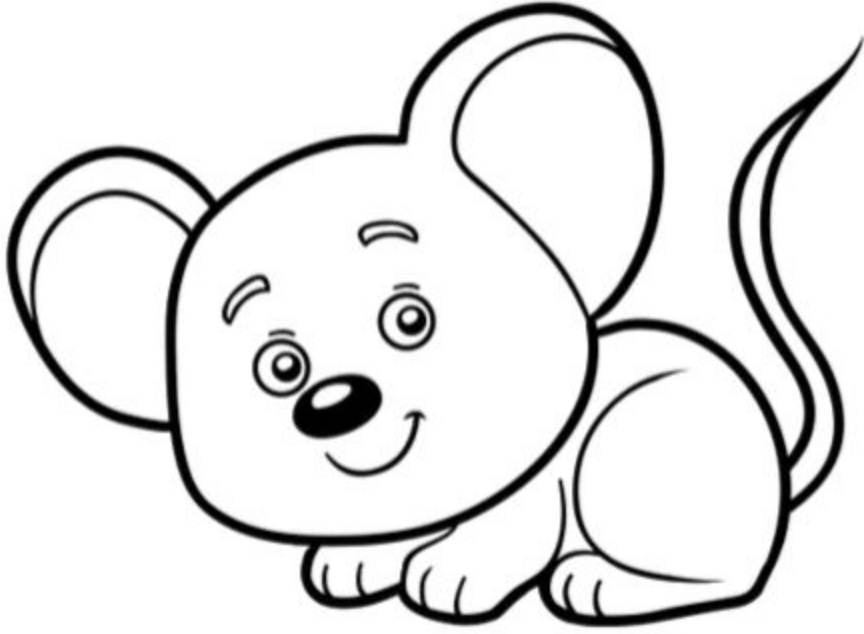

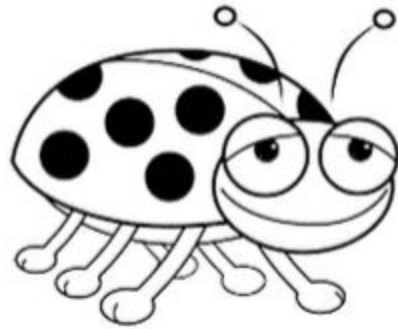
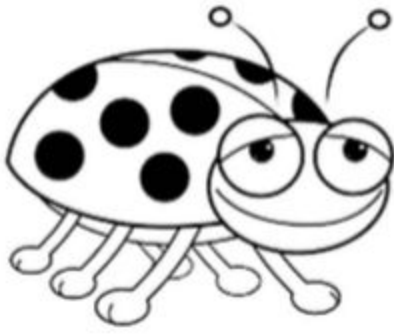
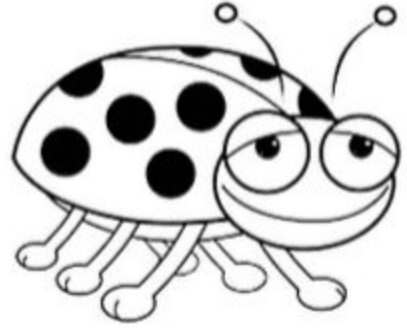
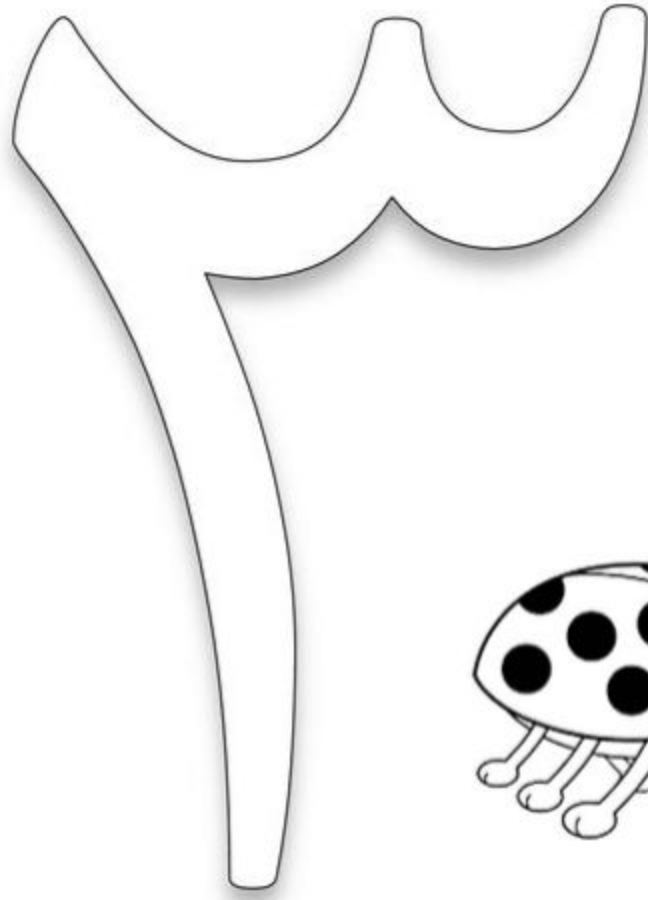

ثلاثة



أرسم ثلاث دوائر ولونهم



لون المربع المحتوي على ثلاث نقط

لون المربع الذي به ثلاث نحلات

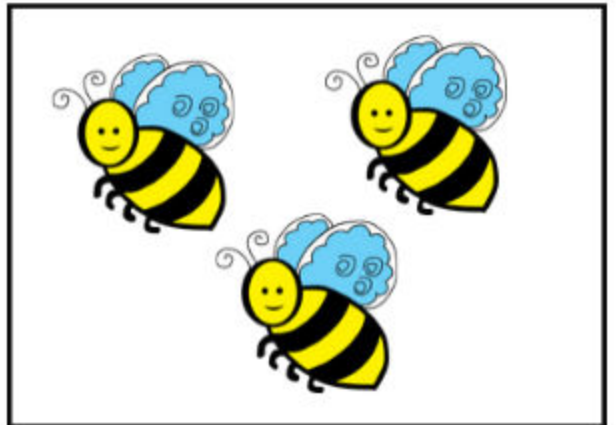
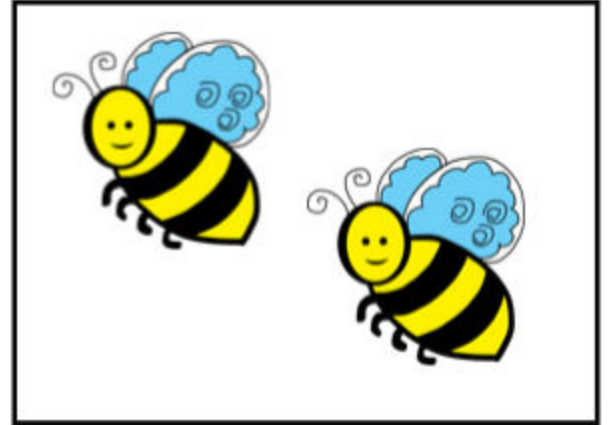
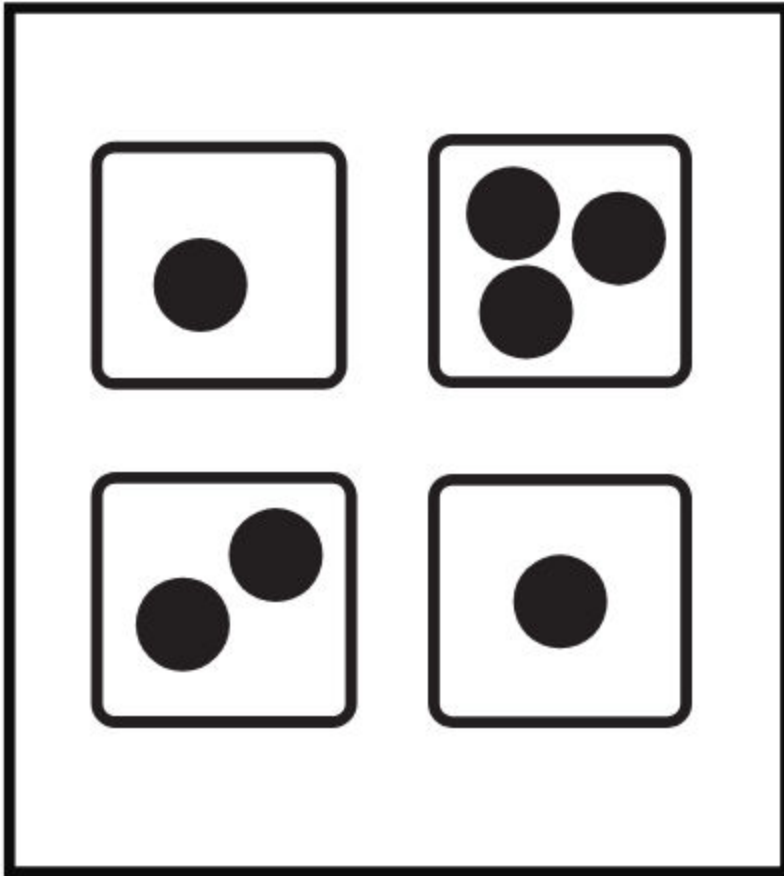

لون وعد وأكتب العدد أسفل الصورة

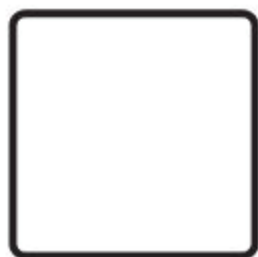
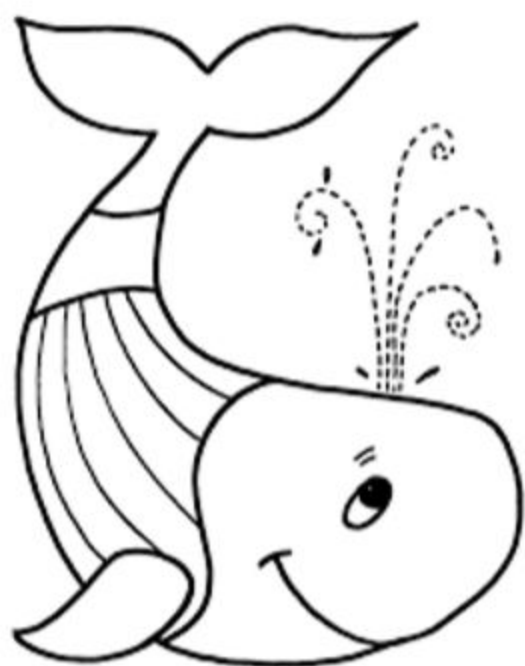
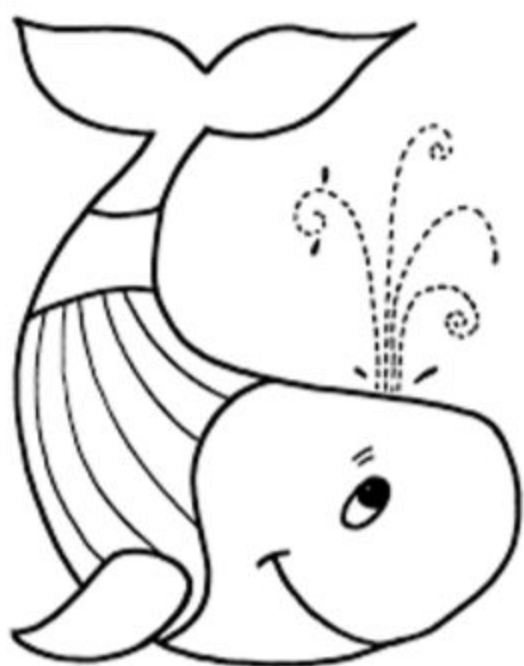

عد الكور وضع دائرة حول العدد المناسب



عد الحيوانات البحرية وصل كل مربع مع العدد المناسب

١

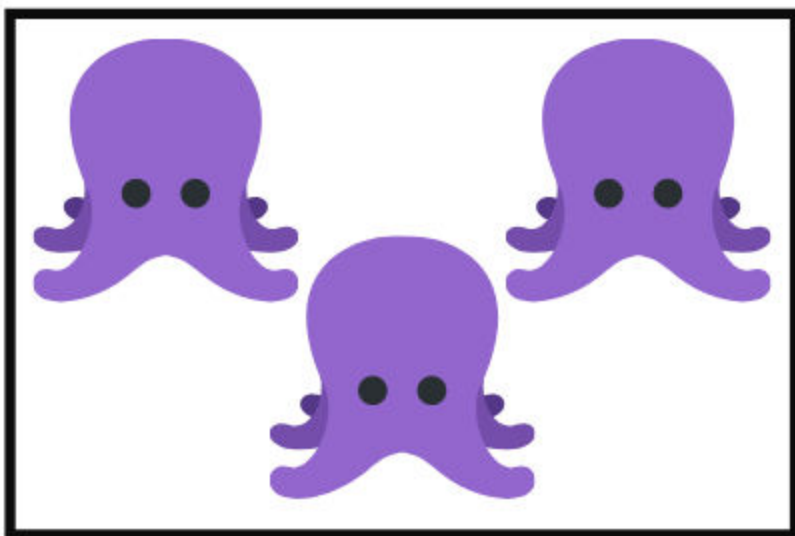

٢

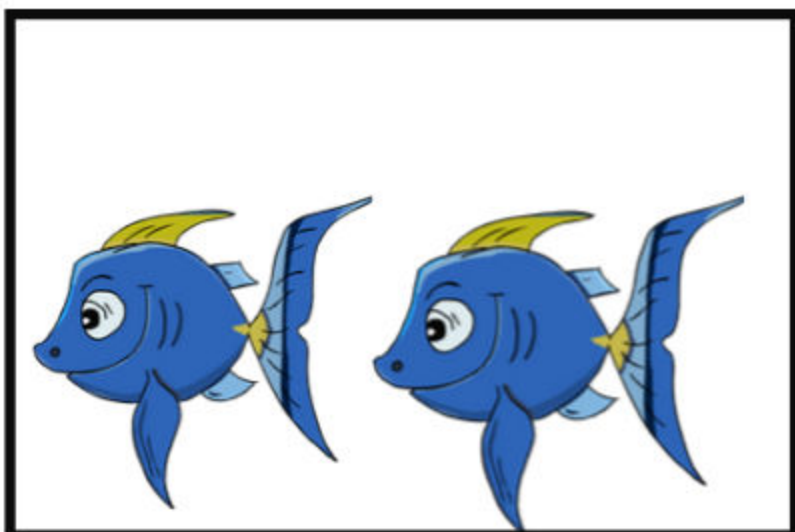

٣

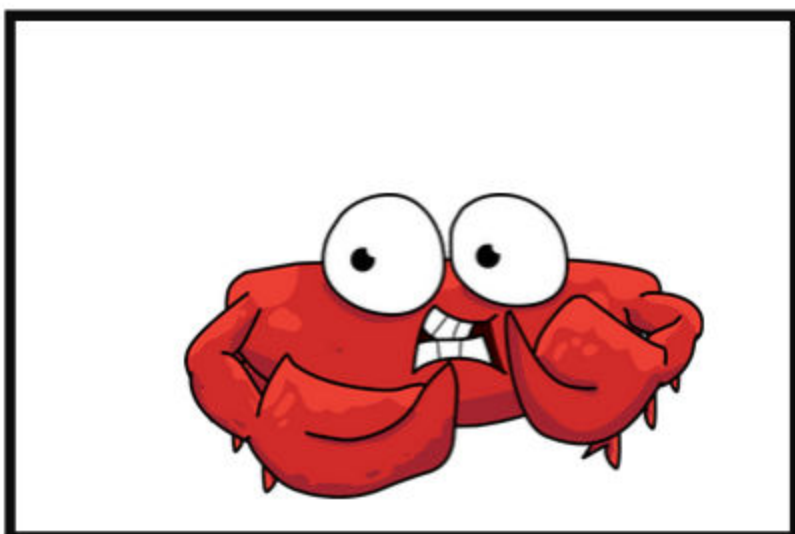

لون من كل شكل العدد المناسب المكتوب بجوار الأشكال

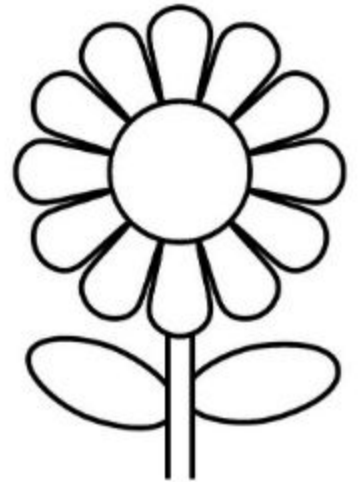
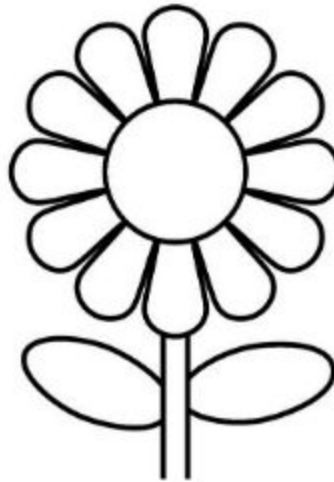
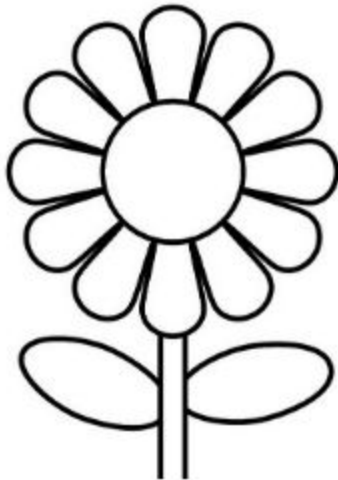
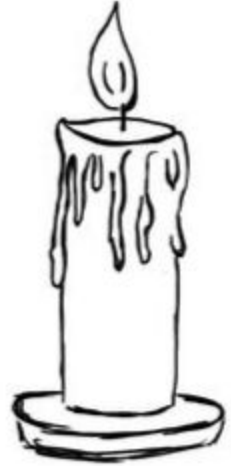

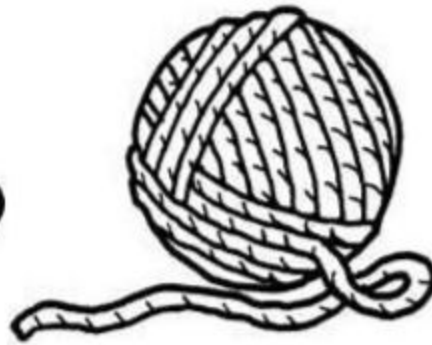
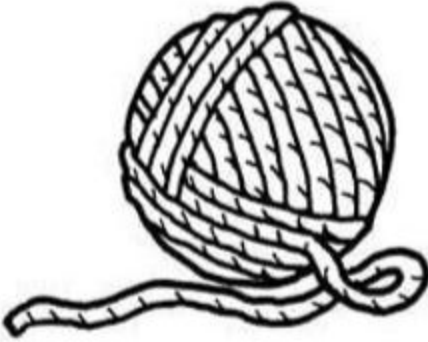
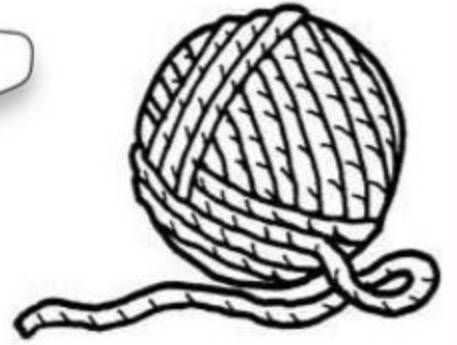
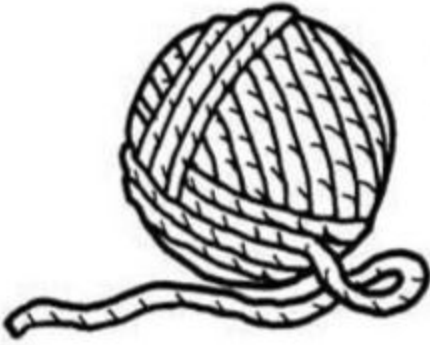

أربعة

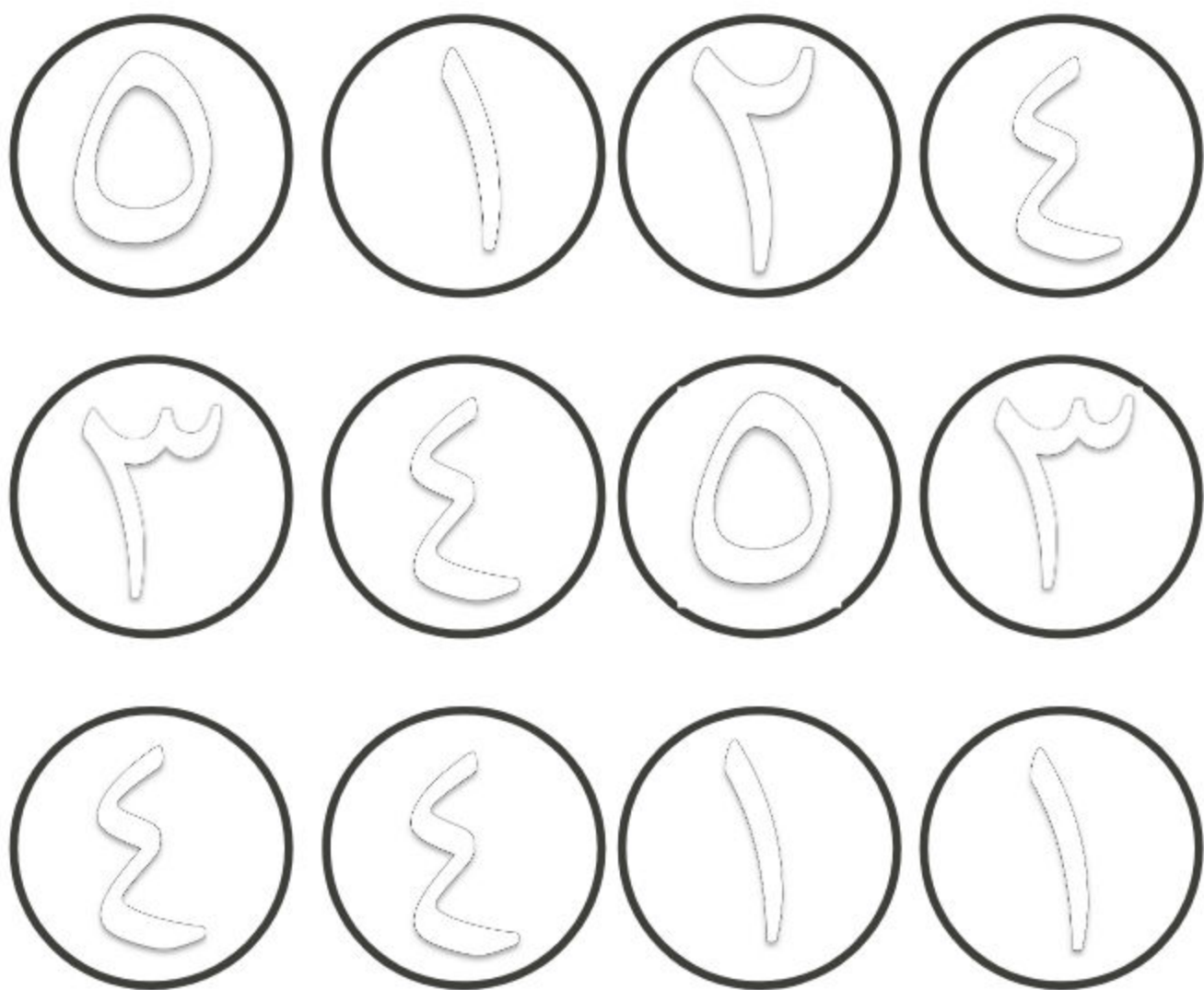

أرسم أربع دوائر ولونهم



لون المربع المحتوي على أربع نقط

لون المربع الذي به أربع أسود

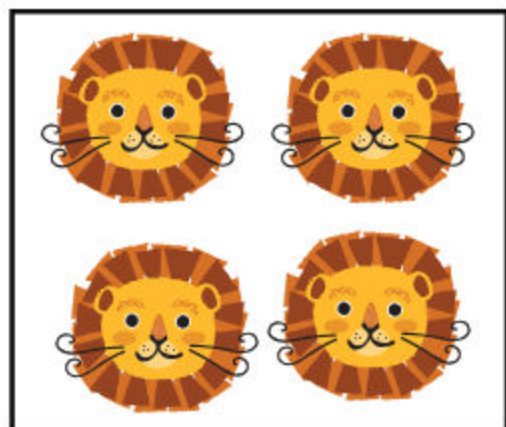
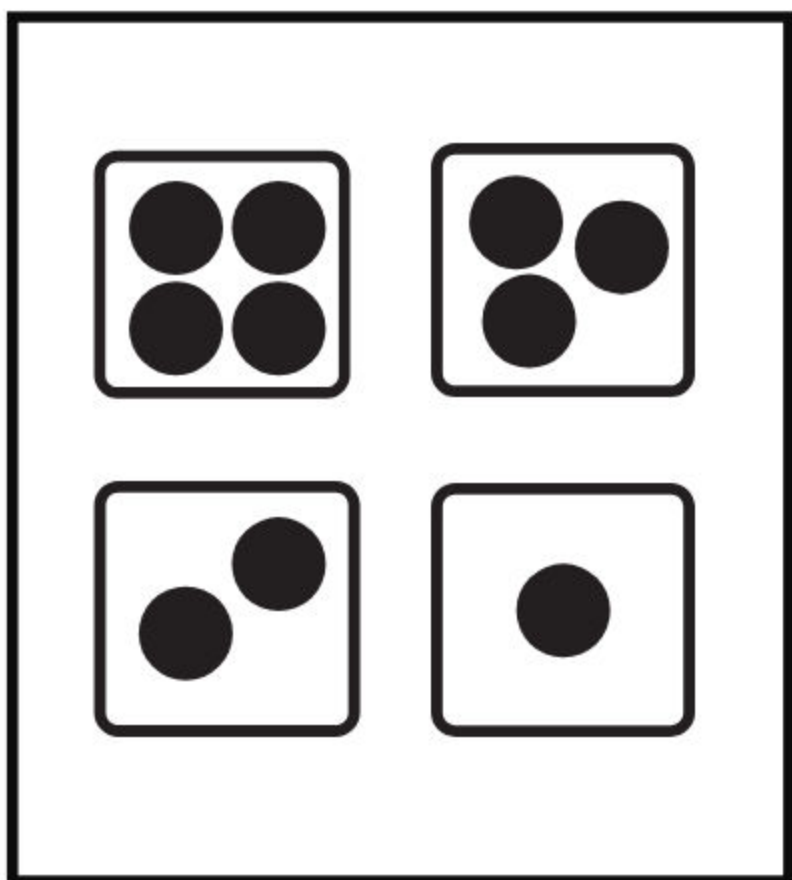

لون وعد وأكتب العدد أسفل الصورة

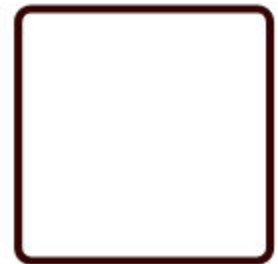
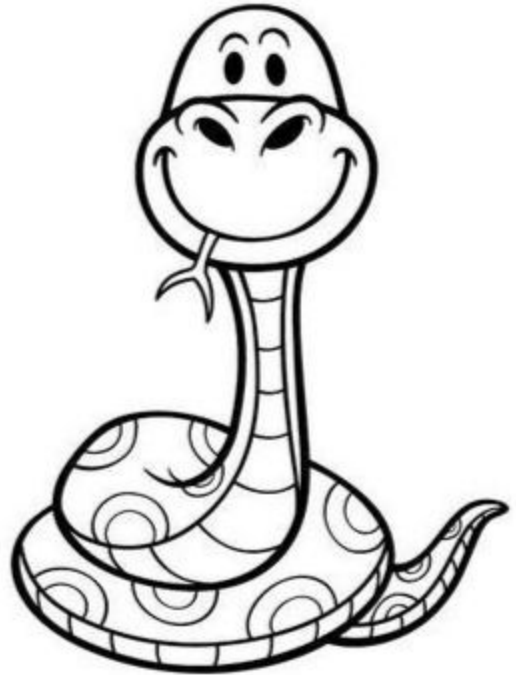
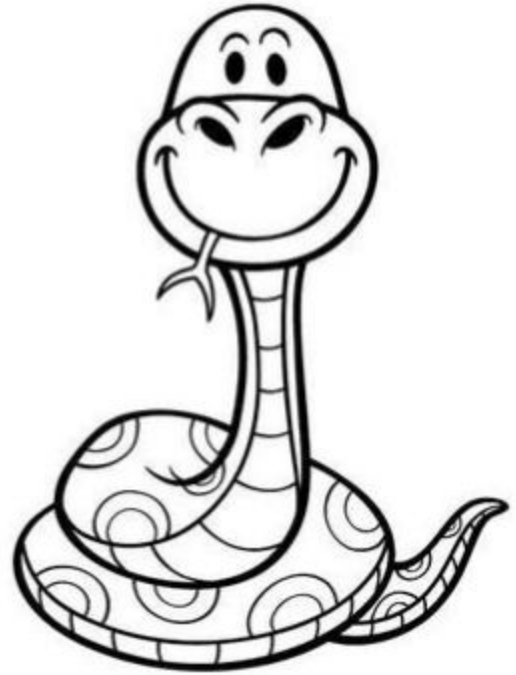

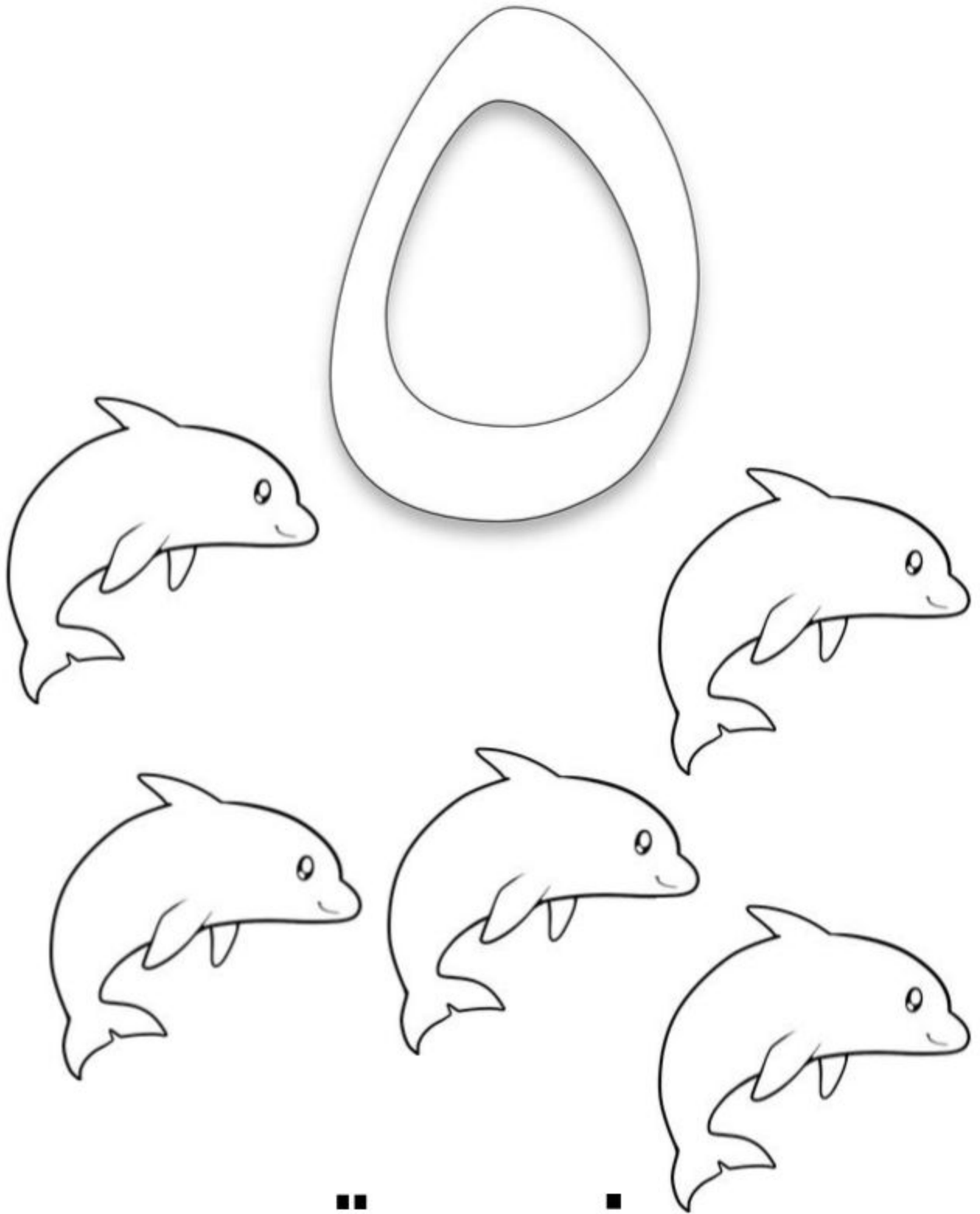

خمسة

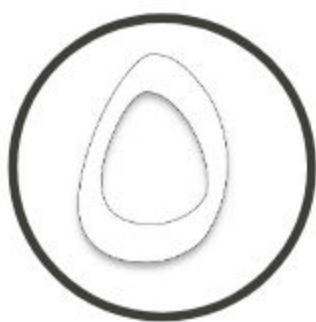

لون المربع الذي به خمس تفاحات

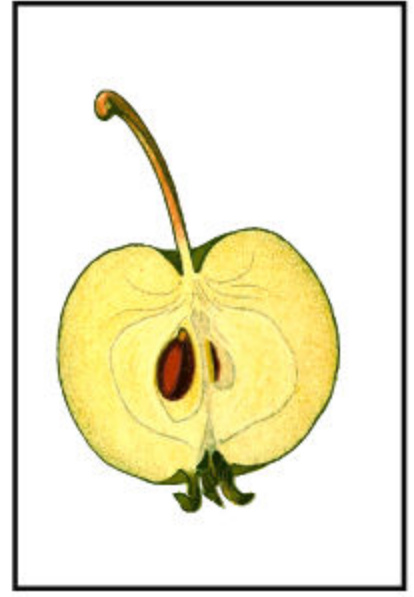
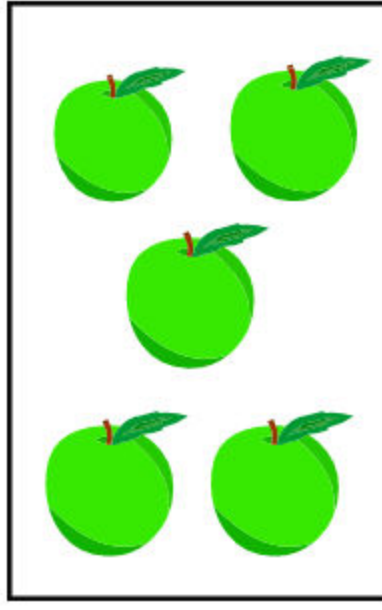
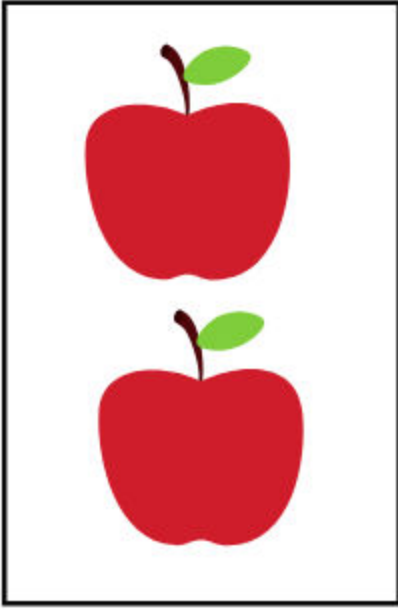

لون المربع المحتوي على خمس نقاط

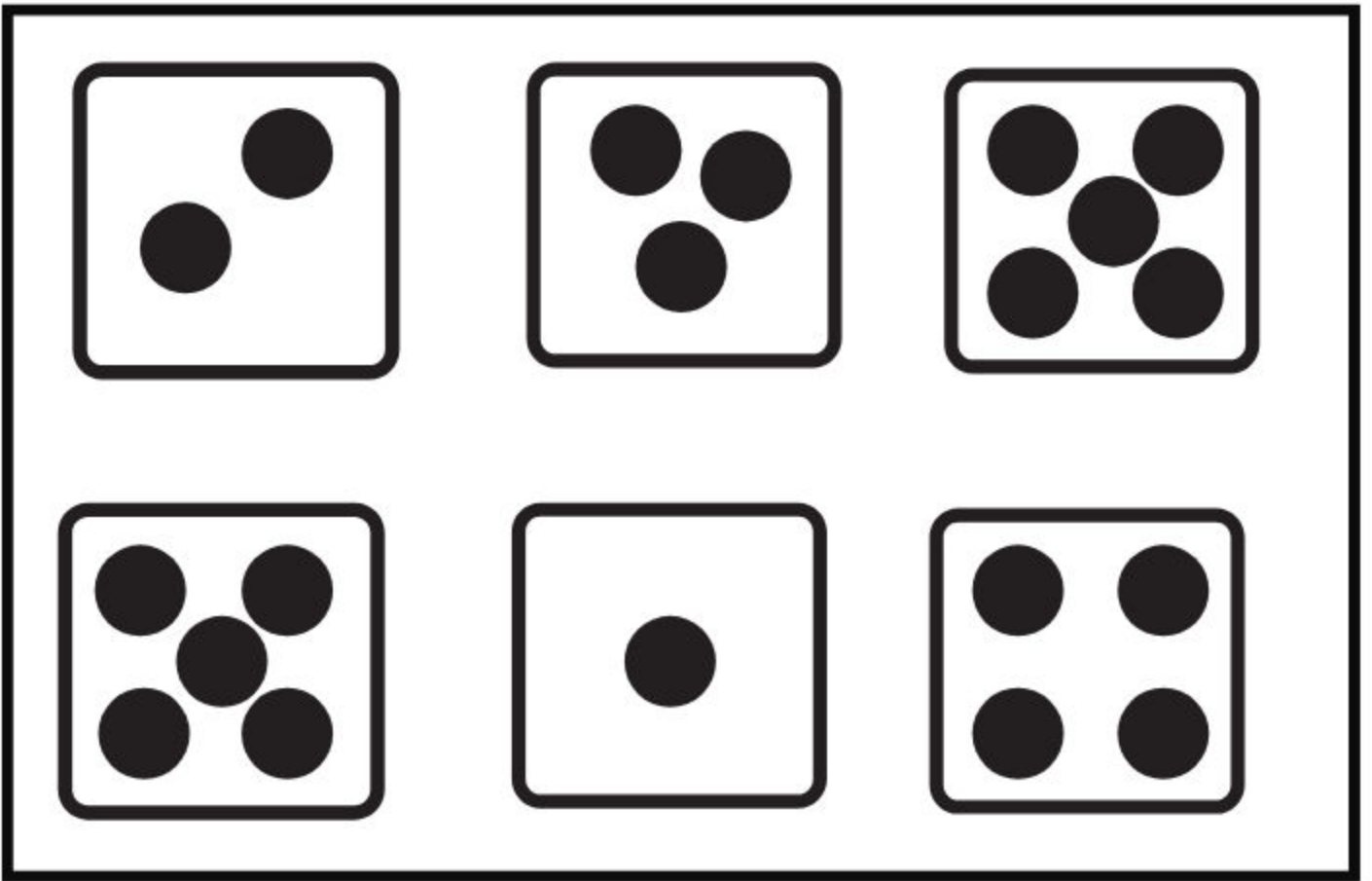

لون وعد وأكتب العدد أسفل الصورة

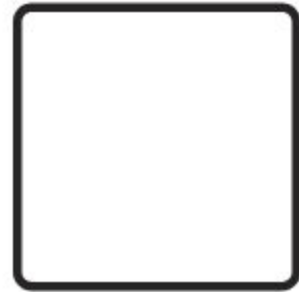
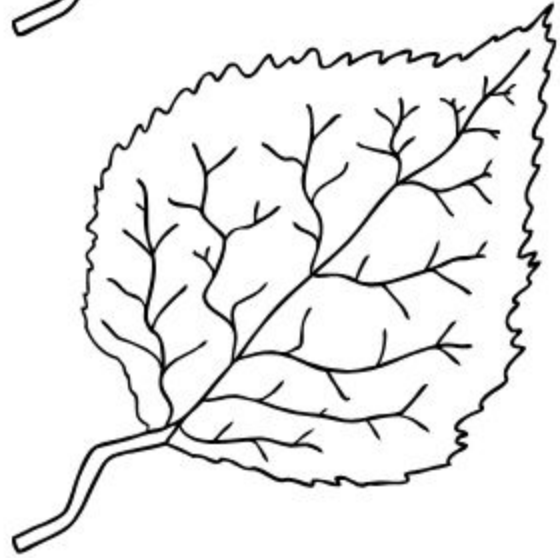

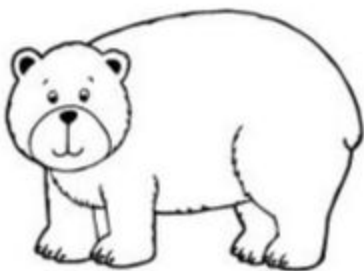
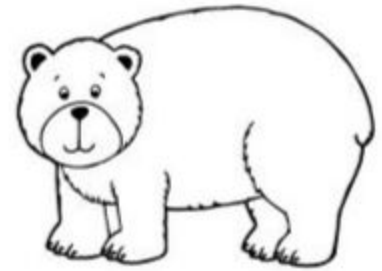
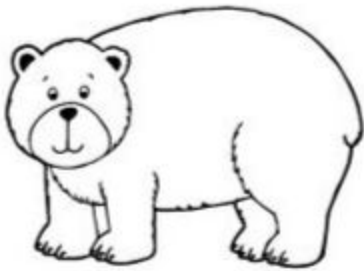
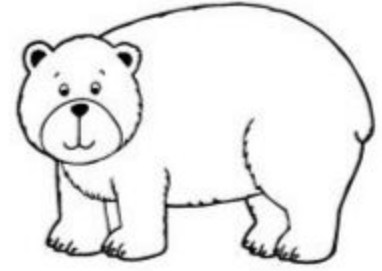
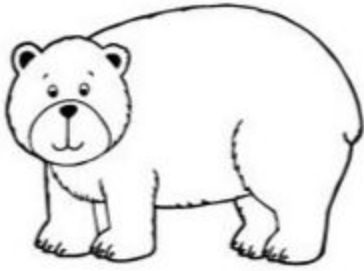
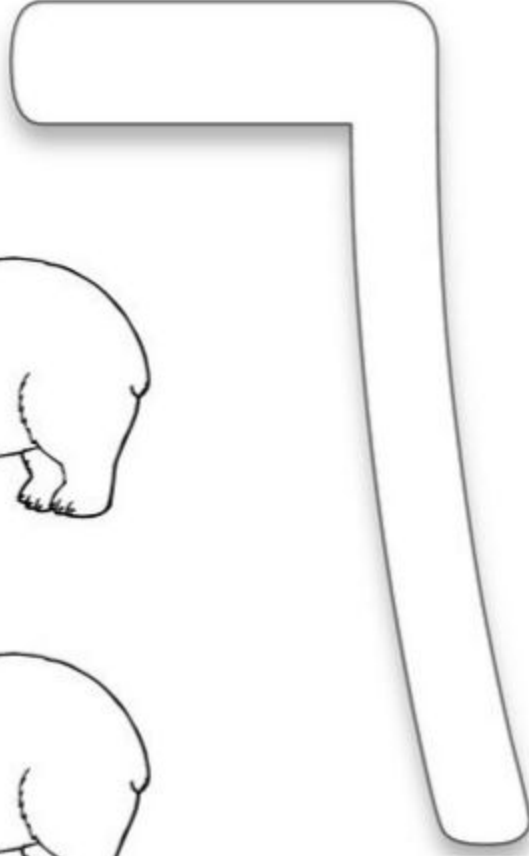

سبعة



لون المربع الذي به ستة سلحفات

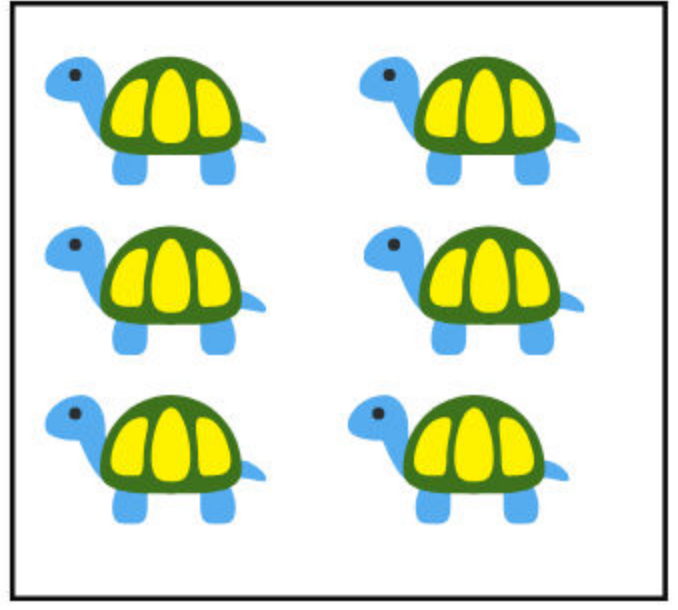
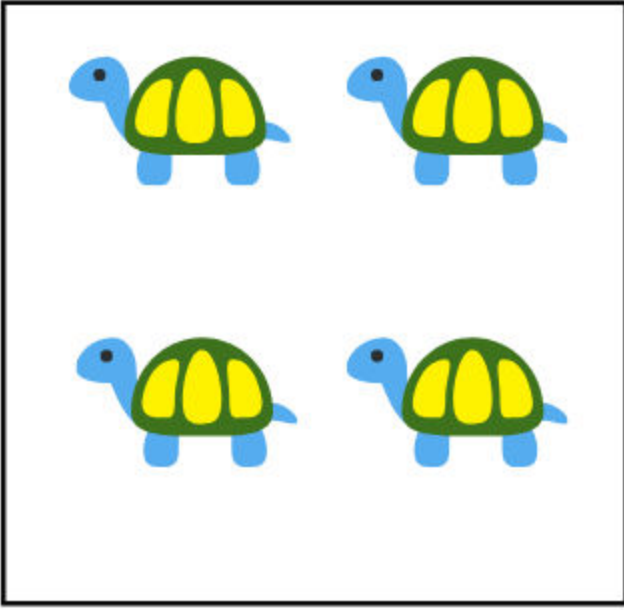

لون المربع المحتوي على ستة نقط

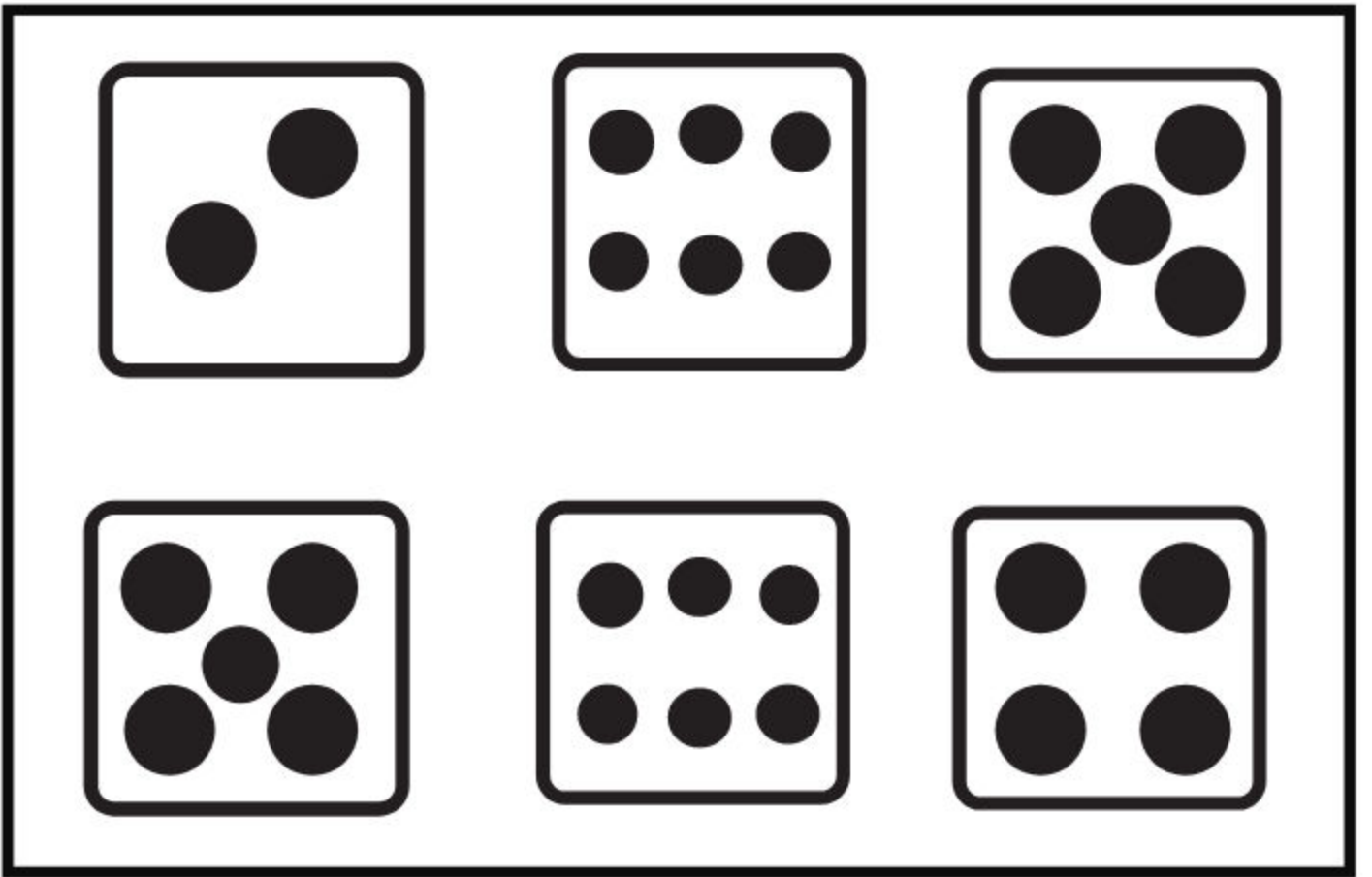

لون وعد وأكتب العدد أسفل الصورة

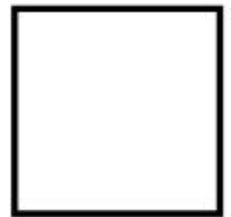

نشاط تنمية المهارات للأطفال في العد

ساعد الطفل على فهم فكرة النشاط
وهو تتبع الأوامر وتنفيذها واحدا تلو الآخر
أقرأ للطفل كل أمر وساعده على البدء
بتنفيذه



لون البالون باللون الأحمر

أرسم ثلاث بالونات أخرى

لون كل بالون بلون مختلف

عد جميع البالونات وأكتب العدد

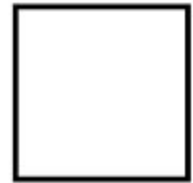

نشاط تنمية المهارات للأطفال في كل من
الملاحظة والعد
بناء النماذج
مهارات ذهنية



أستخدم مكعبات البناء أطلب من طفلك
بناء 3 أبراج بالأطوال التالية مثل الصورة

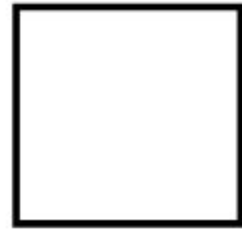
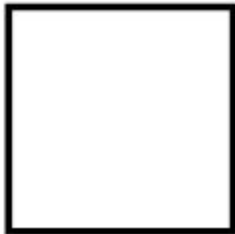

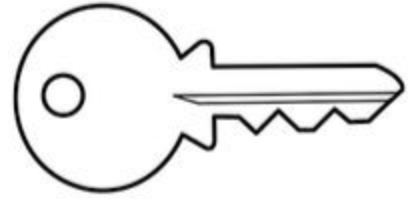
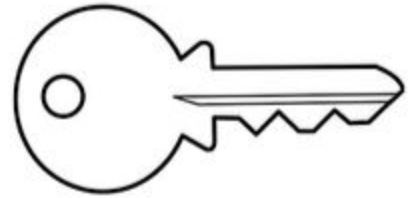
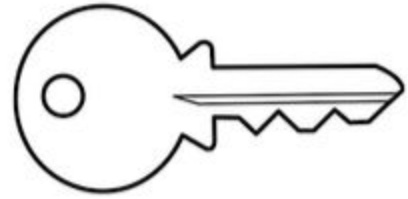
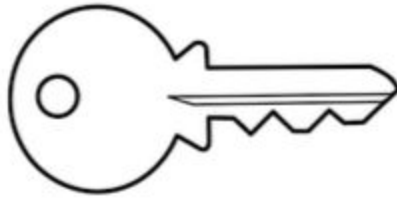
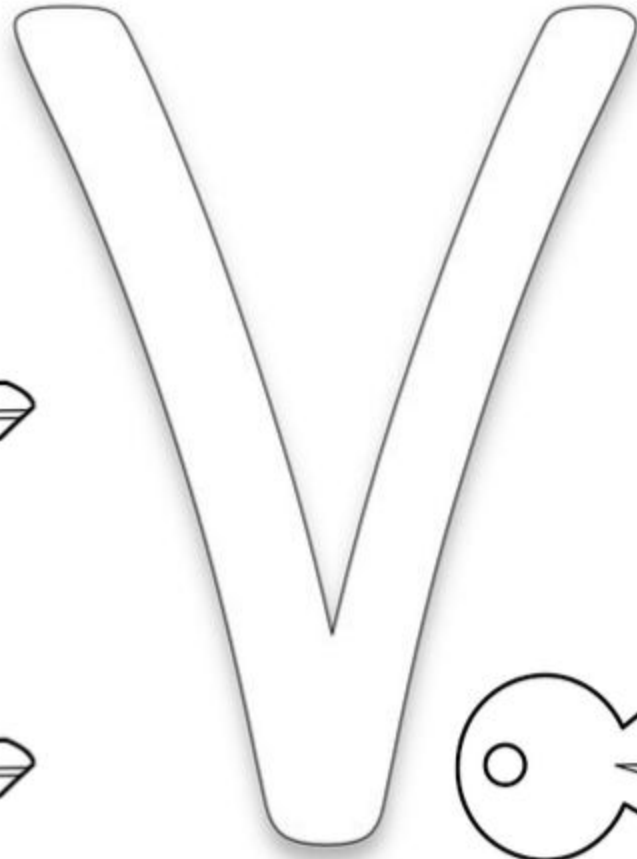

سبعة

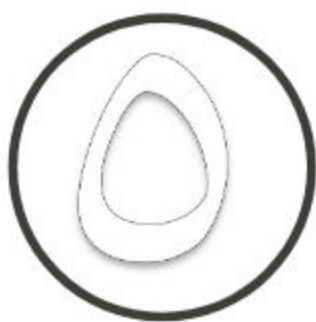

عد ولون سبع أشكال

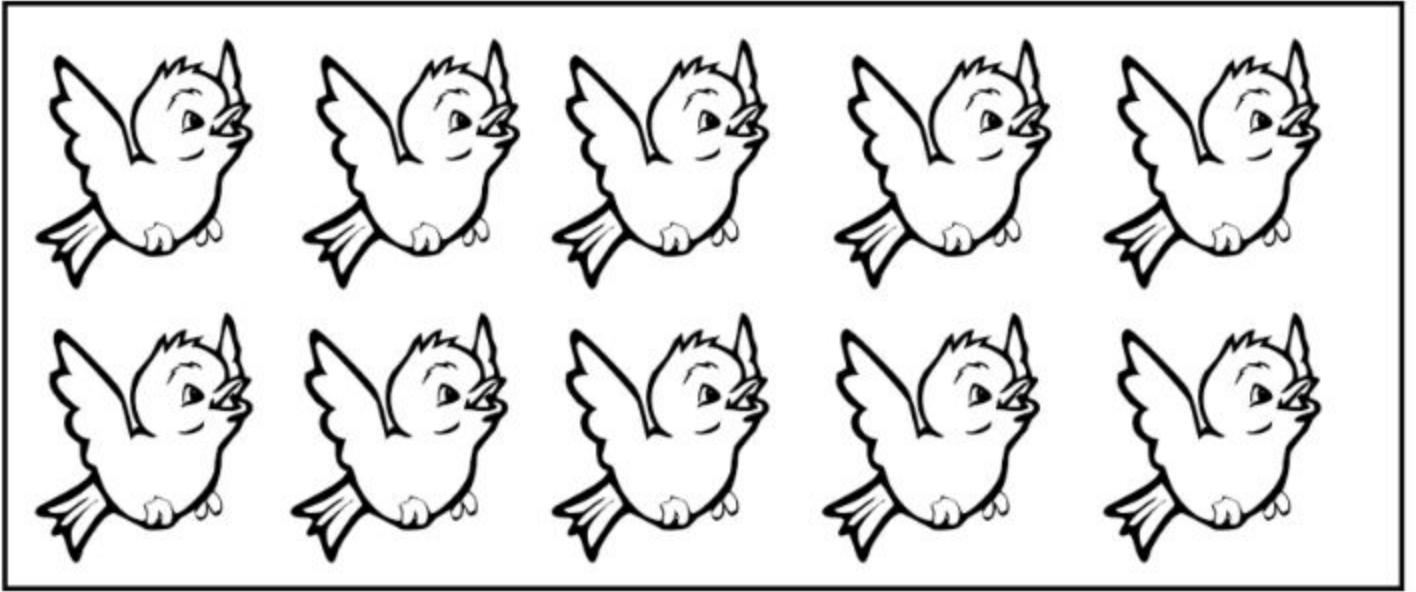

لون الخرزات في السطر المحتوي على 7 خرزات

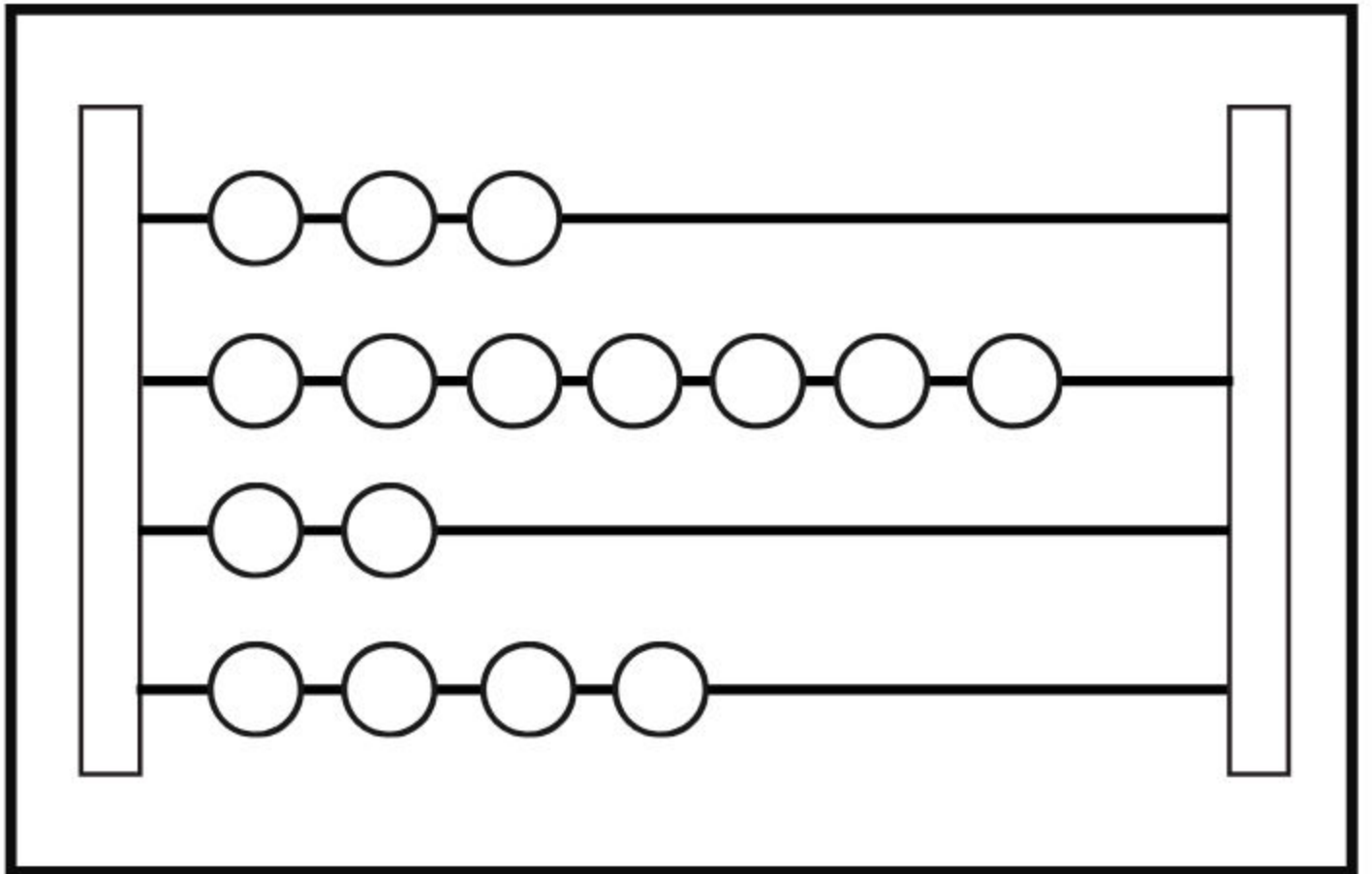

أرسم سبع كرات لمساعدة الدب واللعب ولونهم بألوان
مختلفة



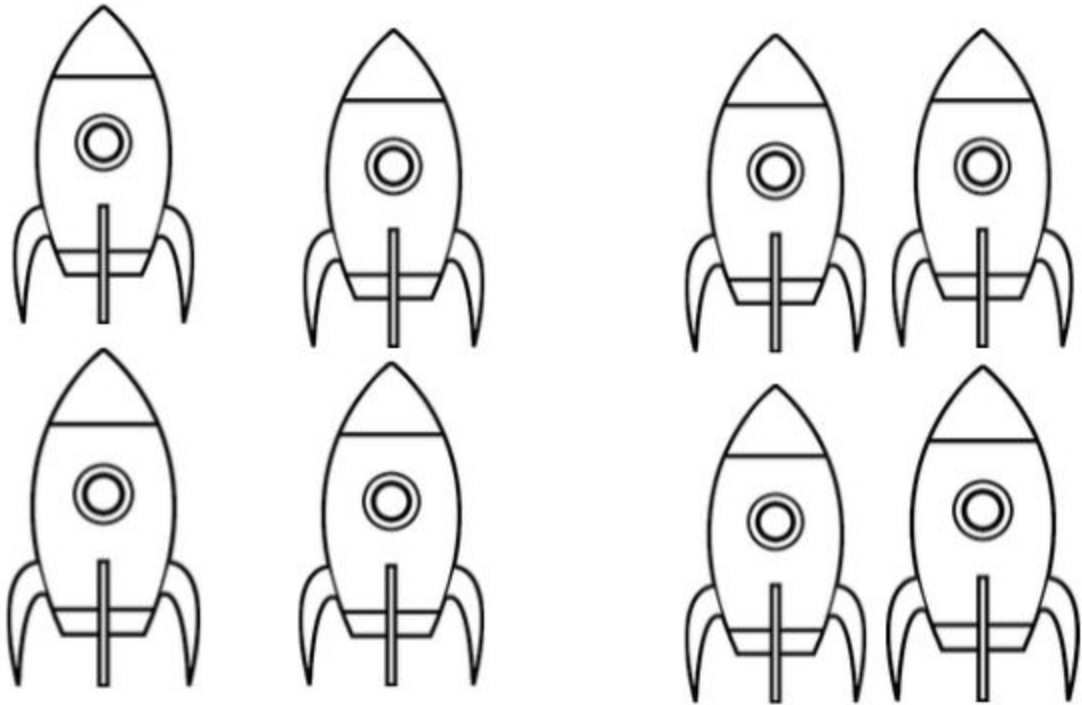
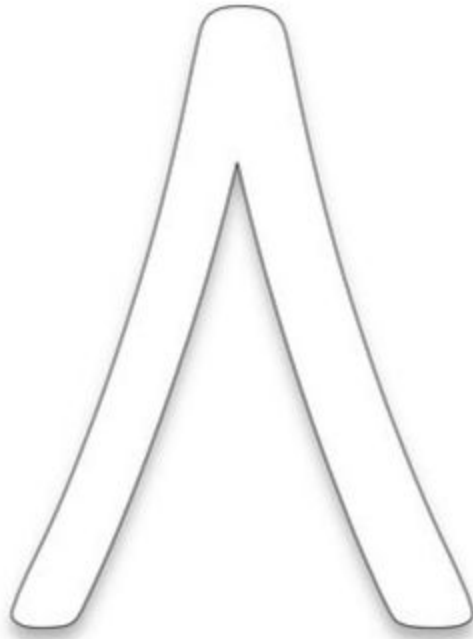

ثمانية



عد ولون ثمانية أشكال

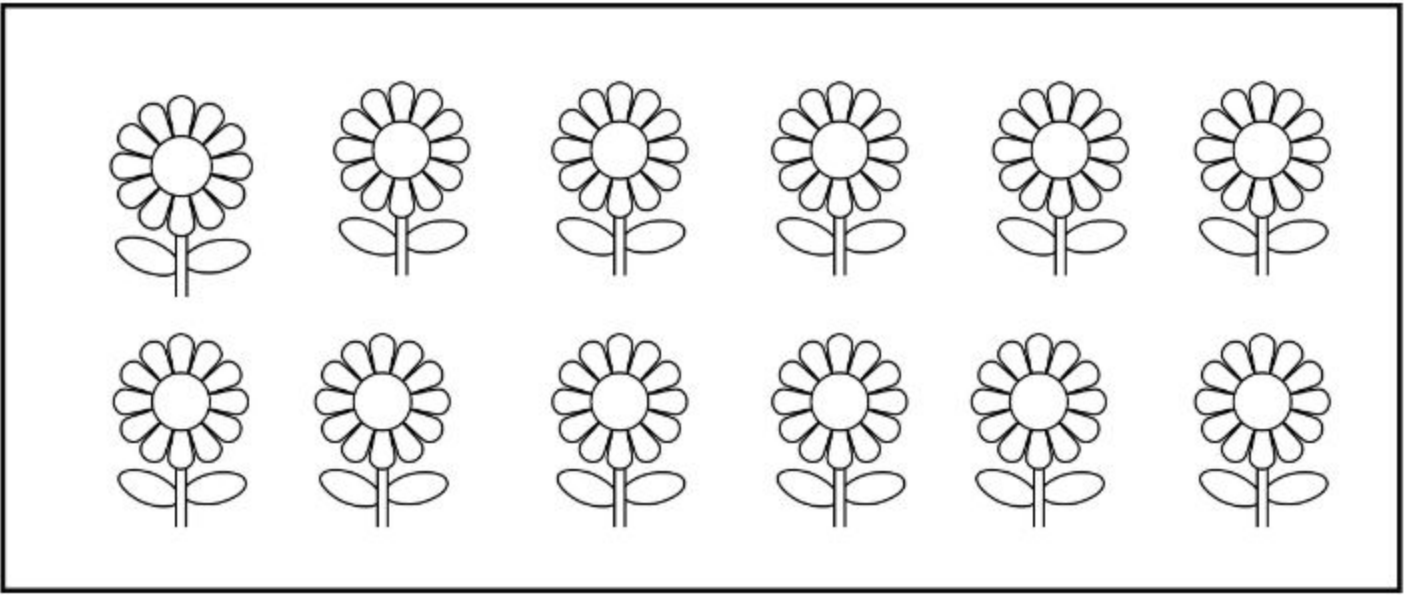

لون الخرزات في السطر المحتوي على 8 خرزات

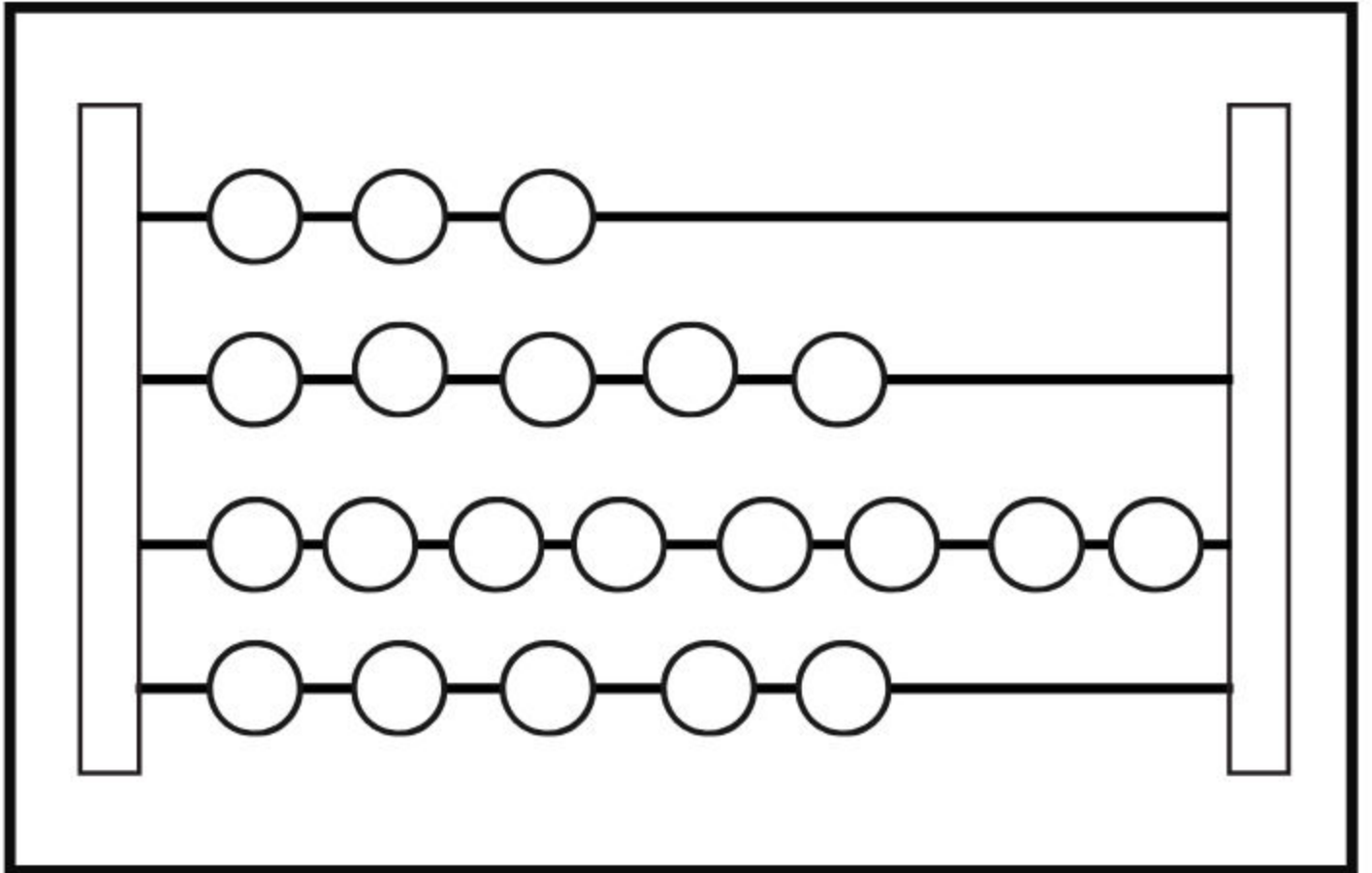



أرسم زهرة لها 8 ورقات وأكتب العدد داخل كل ورقة

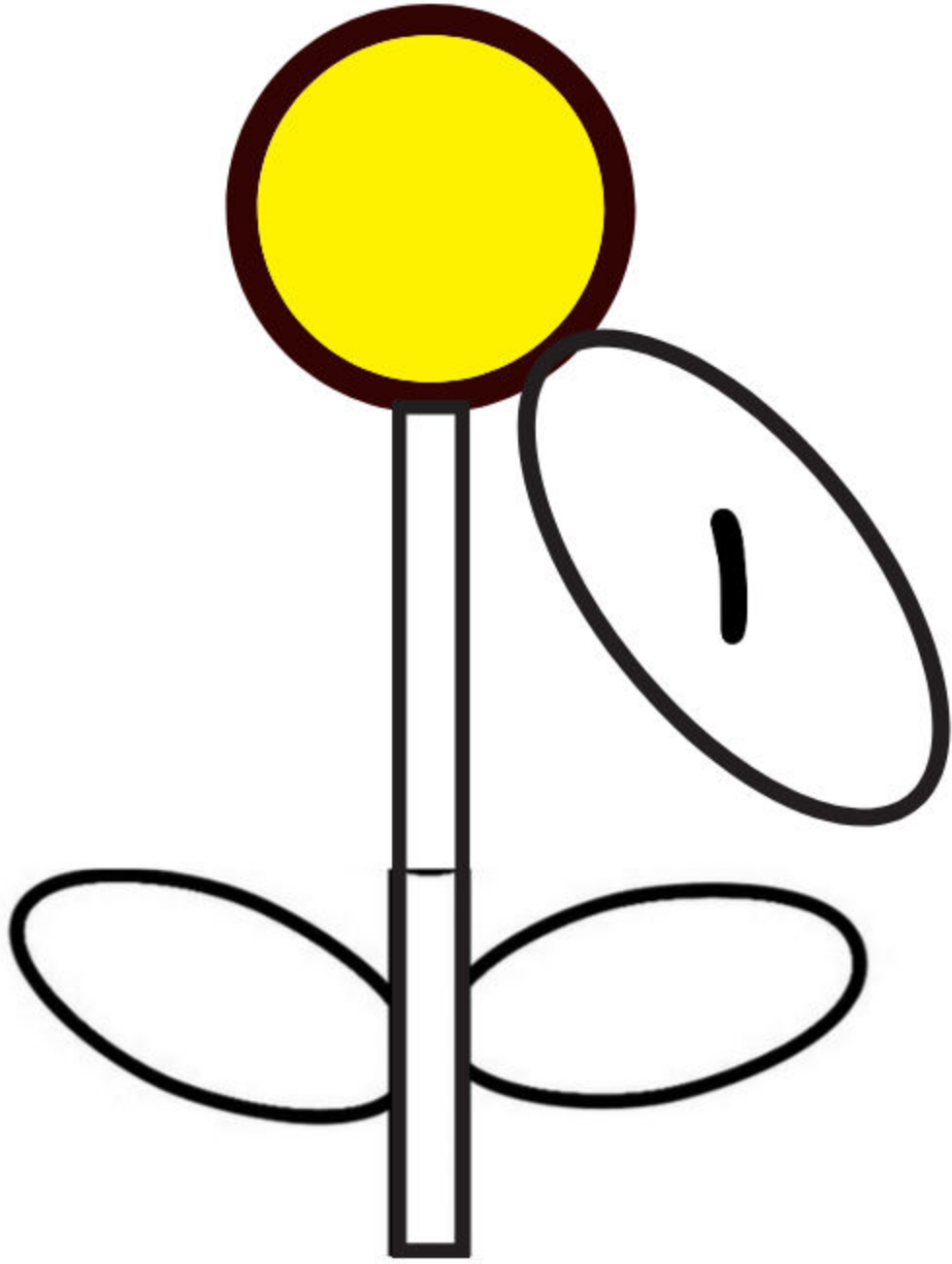

نشاط تمهيد عملية الجمع للطفل
نشاط تنمية مهارات يدوية ورسم وبداية الكتابة
تنمية مهارات الطفل في العد

أشرح للطفل فكرة النشاط وساعده في الرسم ثم
العد
المطلوب أن يصبح في الصورة خمس خراف أطلب من
الطفل رسم خروف وفي كل مرة تقومون بالعد قبل
رسم خروف آخر حتى نستطيع الوصول للعدد
المناسب

هرب خمسة من الخراف من المزرعة لديك واحد في الصورة هل تستطيع رسم أربعة خراف أخرى



٩



تسعة

9 9 9 9 9



عد ولون تسعة أشكال

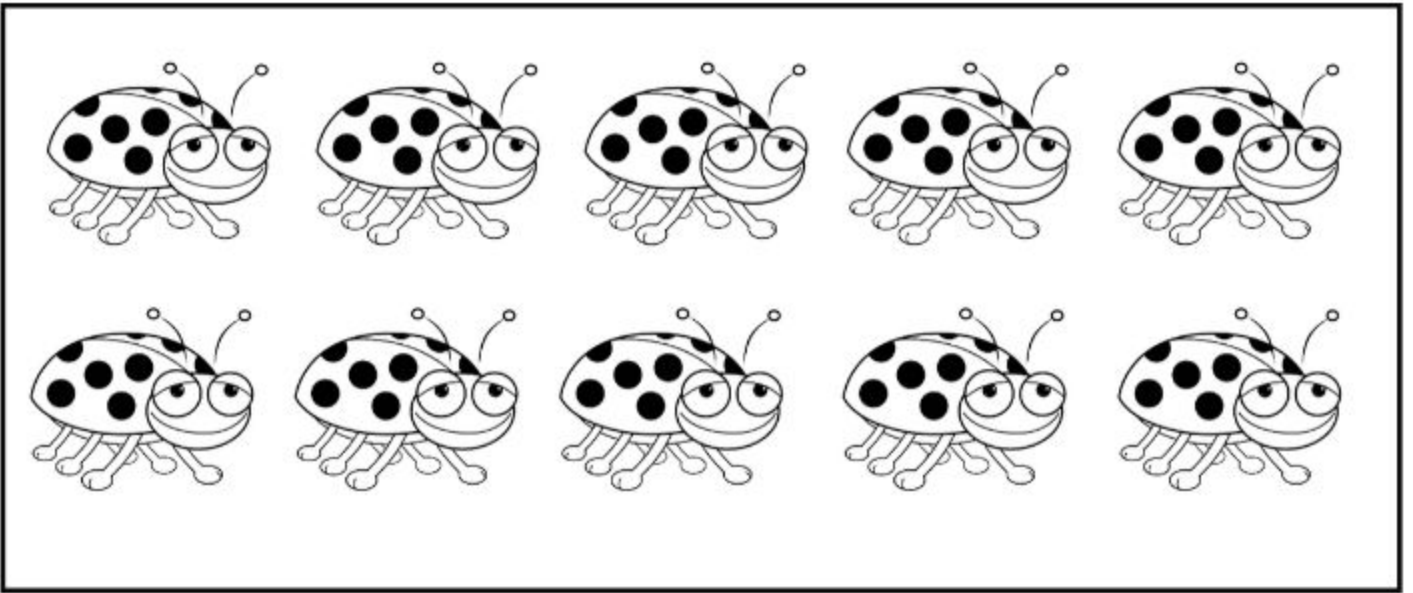

لون الخرزات في السطر المحتوي على تسع خرزات

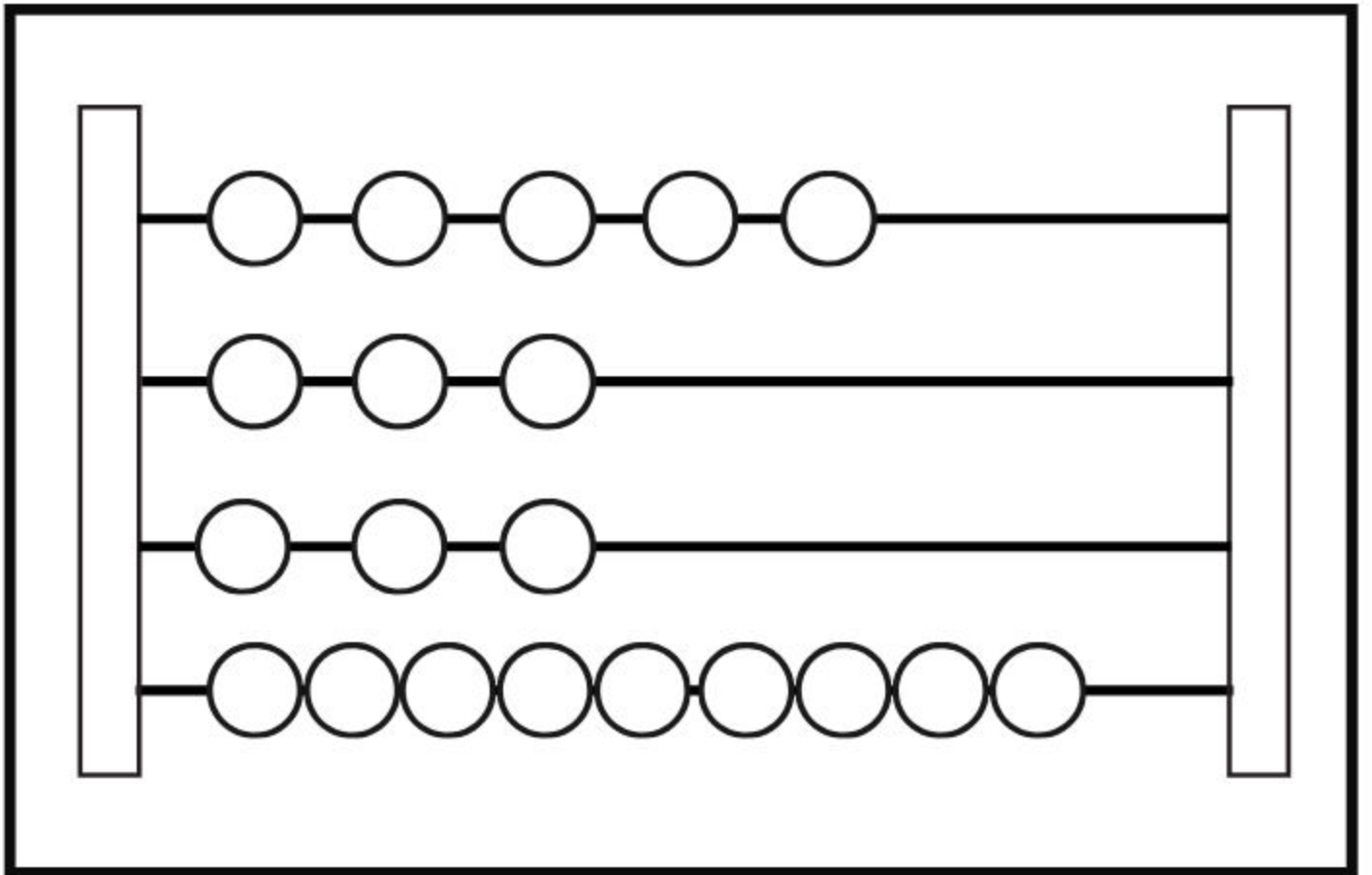



أرسم ولون تسع قطع من الحلوى



أرسم عددا من الصناديق فوق كل شاحنة مناسب للرقم المكتوب عليها

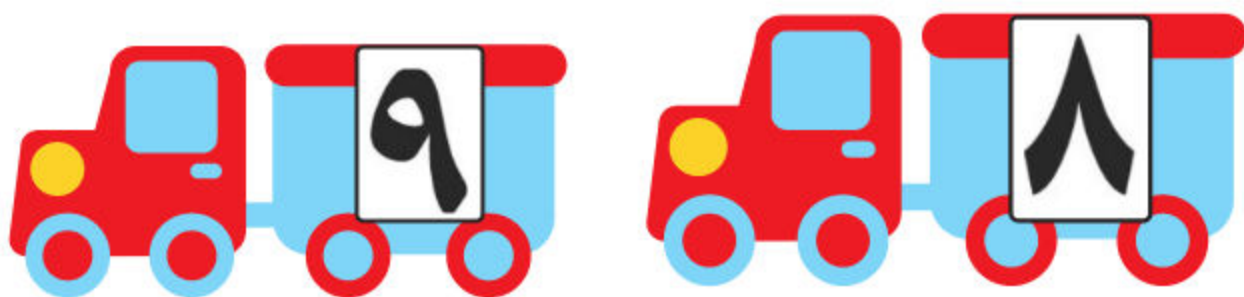

أرسم لكل خنفساء نقط مناسبة للعدد أسفلها



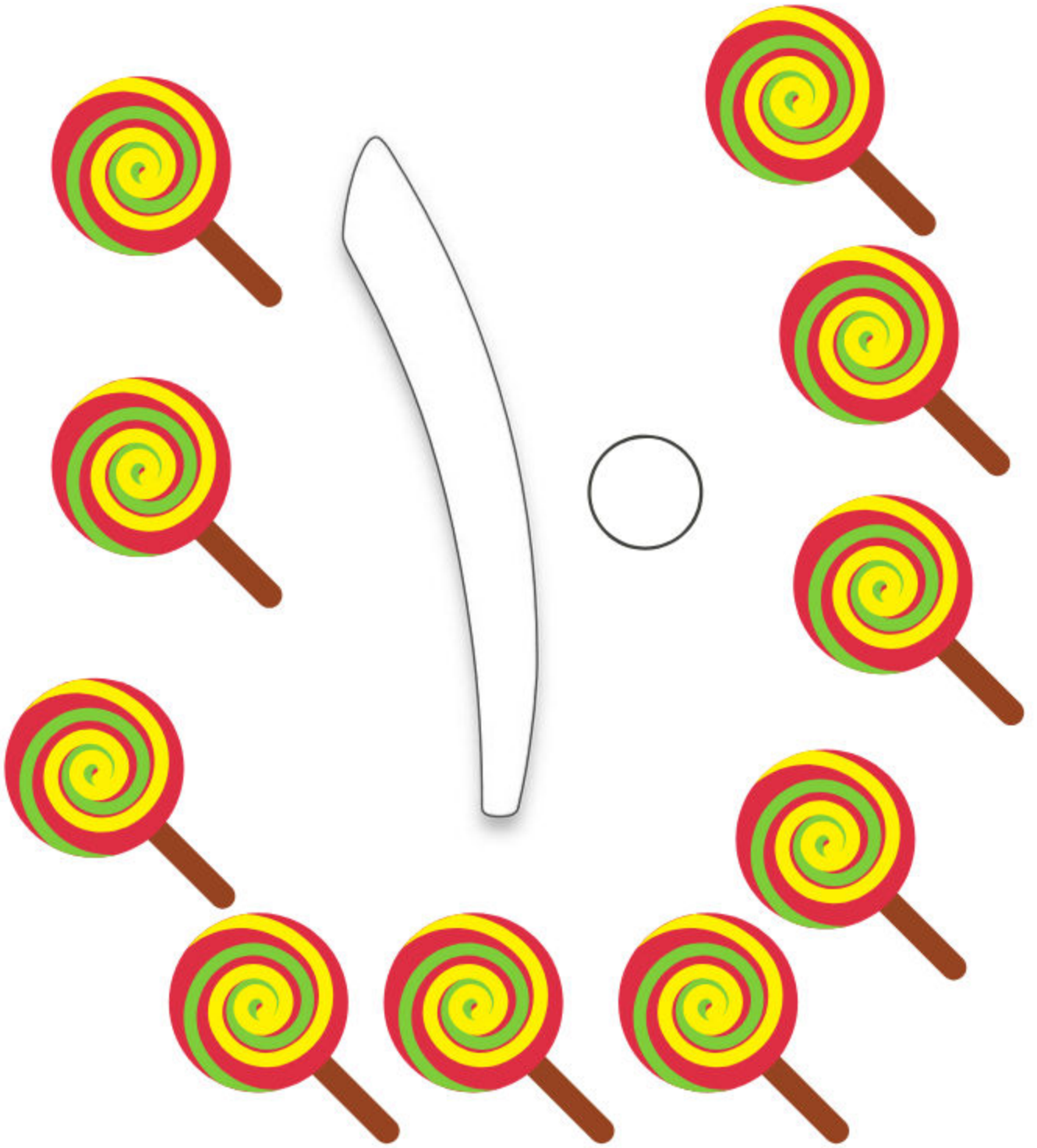

عشرة



هل تستطيع رسم عشر نحلات



عد ولون عشر أشكال

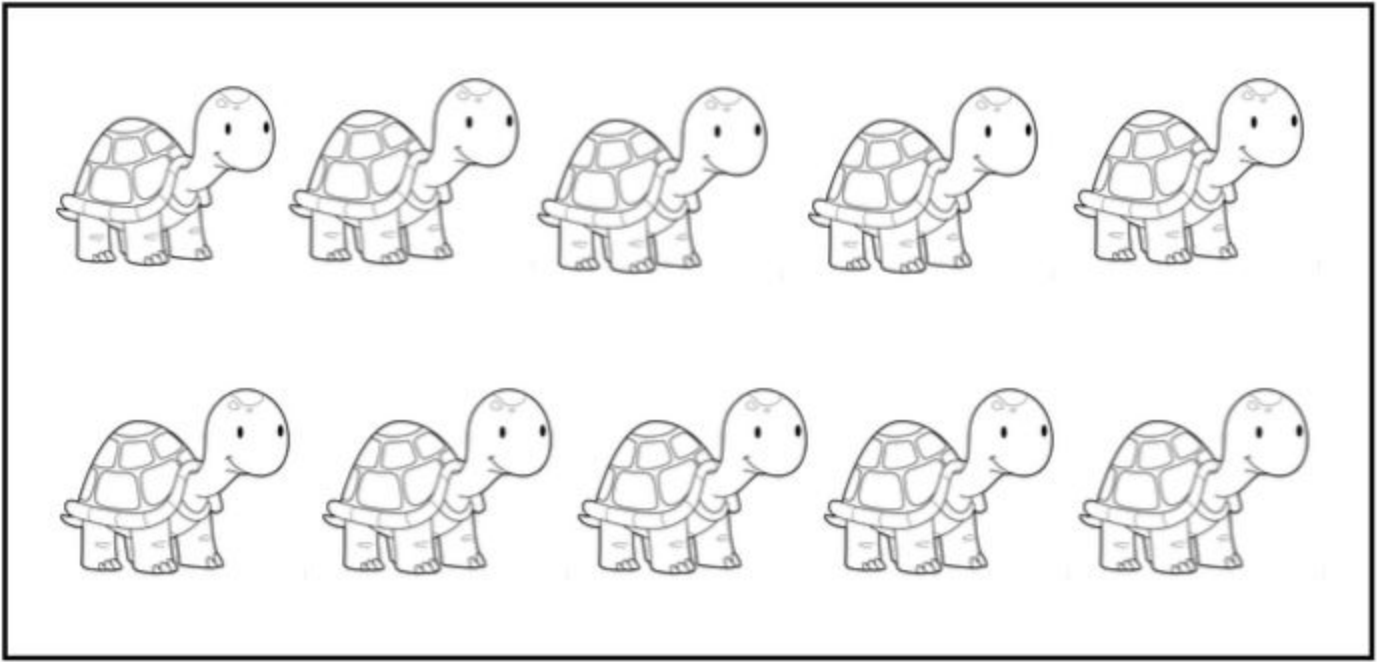

لون الخرزات في السطر المحتوي على عشر خرزات

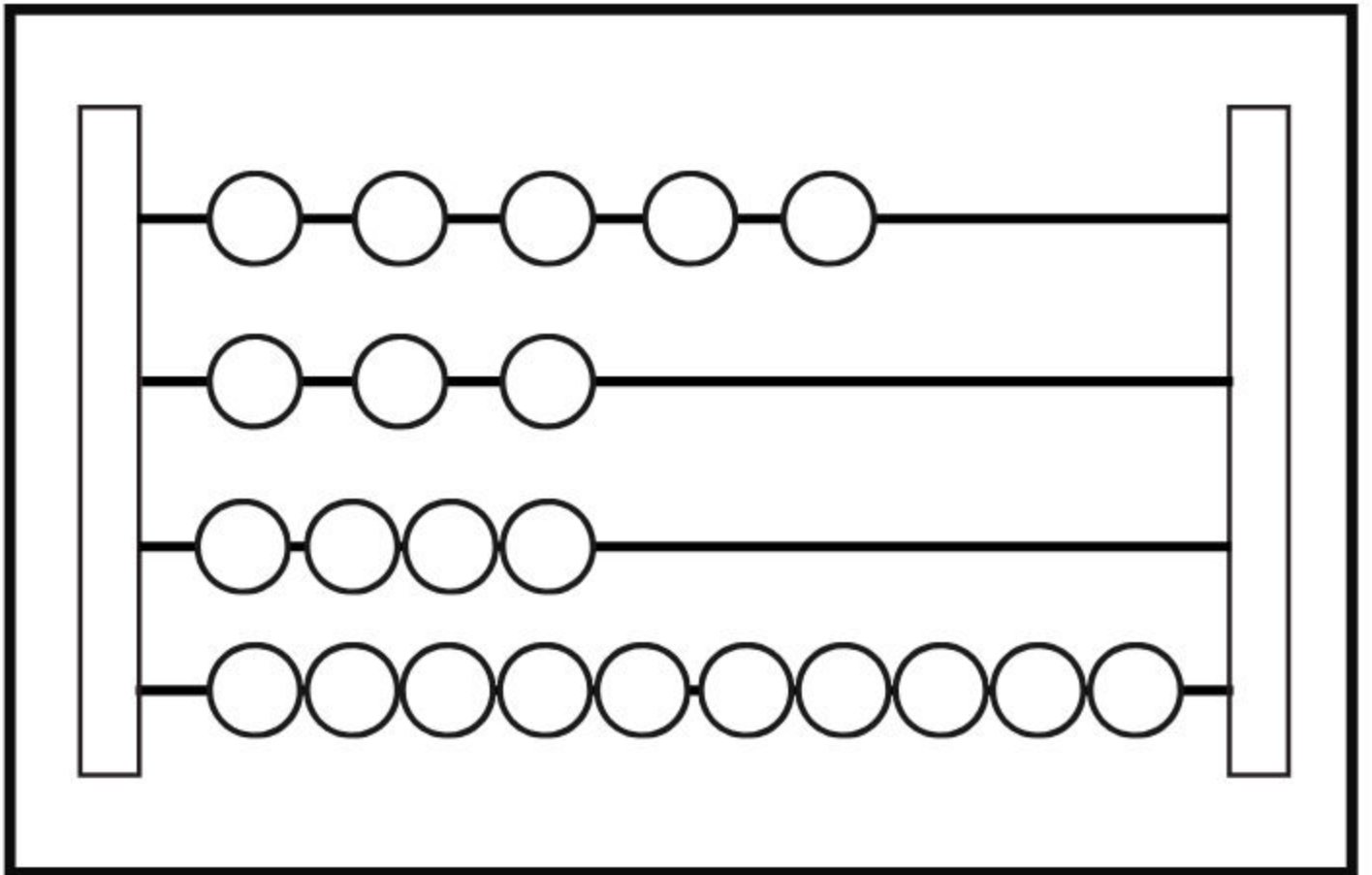

مهارات العد
بداية ادراك الطفل لمفهوم الجمع
رسم وتلوين وتنمية مهارات يدوية

أطلب من الطفل جمع الألوان
المطلوبة بأسفل الصورة وأسأل
كم تفاحة باللون الأحمر يجب أن
أرسم هيا قم برسم تفاحتين
ولونهم باللون الأحمر كم تفاحة
باللون الأخضر يجب أن أرسم
وهكذا وبعد انتهاء الطفل من
الرسم والتلوين أطلب منه عد
جميع التفاح وكتابة الرقم في
المربع

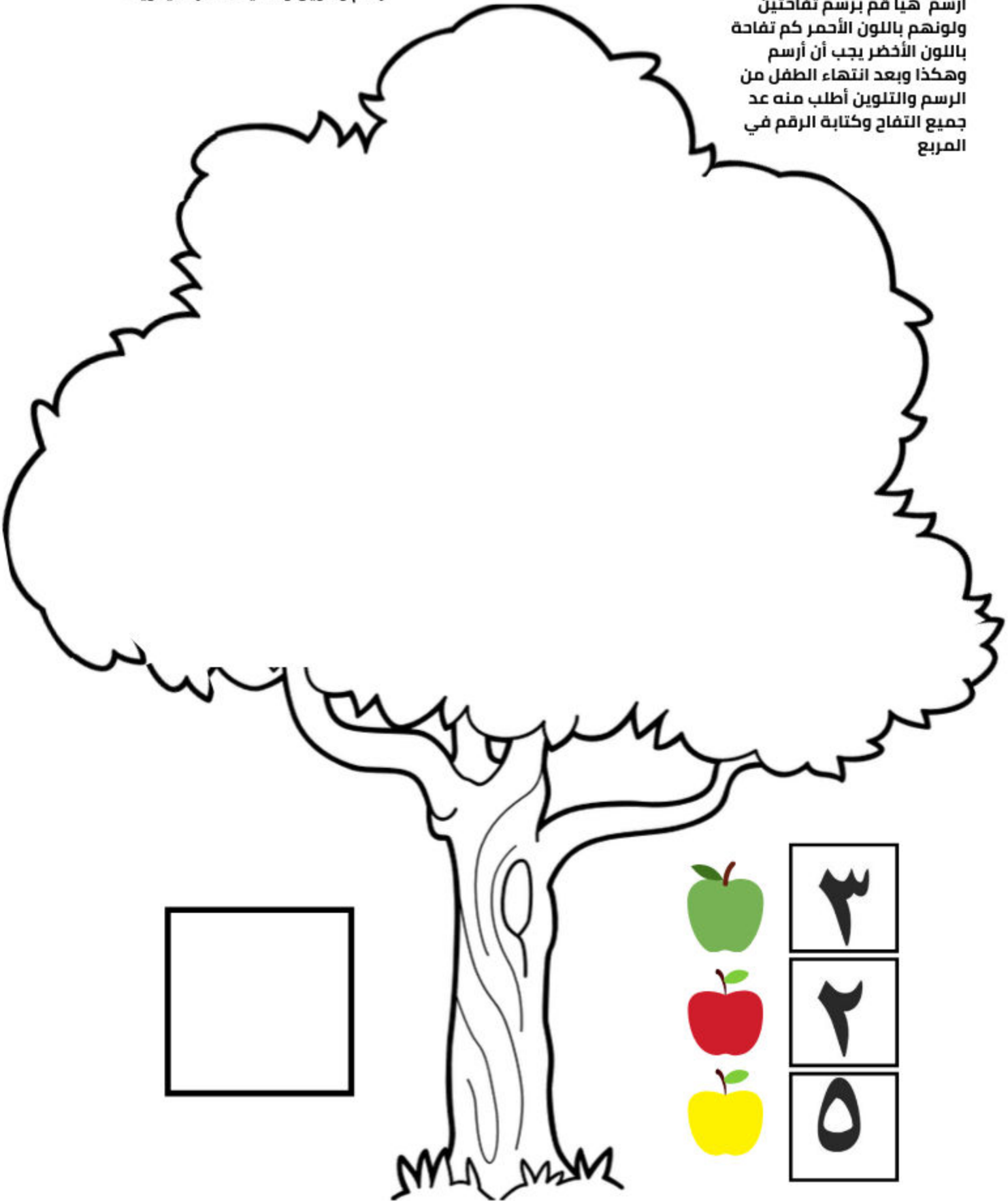

مهارات العد
بداية ادراك الطفل لمفهوم الجمع
رسم وتلوين وتنمية مهارات يدوية
تأدية المهمات بشكل مستقل

هل تستطيع اكمال الرسم
التالي ليصبح رجلا اليا يملك
ثلاث عيون و فمين وخمسة أذرع

